

# SMART Digital XL - DDA

From 60 to 200 l/h

Installation and operating instructions



Further languages

<http://net.grundfos.com/qr/i/98767821>

be  
think  
innovate

**GRUNDFOS** 

# English (GB) Installation and operating instructions

## Original installation and operating instructions

## CONTENTS

	Page		Page
<b>1. General information</b>	<b>3</b>	7.3.3 Alarm	24
1.1 Symbols used in this document	3	7.3.4 Setup	25
1.2 Qualification and training	3	7.4 Operation modes	25
1.3 Safety instructions for the operator/user	3	7.4.1 Manual	25
1.4 Safety of the system in the event of a failure in the dosing pump	4	7.4.2 Pulse	26
1.5 Dosing chemicals	4	7.4.3 Analog 0/4-20 mA	26
1.6 Diaphragm leakage	4	7.4.4 Batch (pulse-based)	27
1.6.1 Diaphragm leakage detection (optional)	5	7.4.5 Dosing timer cycle	28
<b>2. Storage and handling</b>	<b>5</b>	7.4.6 Dosing timer week	29
2.1 Storage	5	7.5 Analog output	30
2.2 Unpacking	5	7.6 SlowMode	30
2.3 Transport	5	7.7 Stop after power failure	31
<b>3. Product introduction</b>	<b>6</b>	7.8 FlowControl	32
3.1 Applications	6	7.9 Pressure monitoring	33
3.2 Improper operating methods	6	7.9.1 Pressure setting ranges	33
3.3 Symbols on the pump	7	7.9.2 Calibration of pressure sensor	33
3.4 Nameplate	7	7.10 Flow measurement	34
3.5 Type key	8	7.11 AutoFlowAdapt	34
3.6 Product overview	9	7.12 Auto deaeration	34
<b>4. Technical data / Dimensions</b>	<b>10</b>	7.13 Diaphragm leak. detect.	34
4.1 Technical data	10	7.14 Key lock	35
4.2 Technical data for CIP (Clean-In-Place) applications	12	7.14.1 Temporary deactivation	35
4.2.1 Dimensions	12	7.14.2 Deactivation	35
<b>5. Assembly and installation</b>	<b>13</b>	7.15 Display setup	35
5.1 Pump assembly	13	7.15.1 Units	35
5.1.1 Requirements	13	7.15.2 Additional display	35
5.1.2 Aligning and installing the mounting plate	13	7.16 Time+date	36
5.1.3 Installing the pump on the mounting plate	13	7.17 Bus communication	36
5.1.4 Adjusting the control cube position	14	7.17.1 GENibus communication	36
5.2 Hydraulic connection	14	7.17.2 Possible industrial bus types	36
5.3 Electrical connection	16	7.17.3 Activate communication	36
<b>6. Startup</b>	<b>18</b>	7.17.4 Setting the bus address	37
6.1 Preparing the pump for startup	18	7.17.5 Characteristics of bus communication	37
6.2 Starting up the pump	18	7.17.6 Deactivate communication	37
6.3 Setting the menu language	19	7.17.7 Communication faults	37
6.4 Deaerating the pump	20	7.18 Inputs/Outputs	38
6.5 Calibrating the pump	20	7.18.1 Relay outputs	38
6.5.1 Calibration process - example for DDA 60-10	21	7.18.2 External stop	39
<b>7. Operation</b>	<b>22</b>	7.18.3 Empty and Low level signals	39
7.1 Control elements	22	7.19 Basic settings	39
7.2 Display and symbols	22	<b>8. Service</b>	<b>40</b>
7.2.1 Navigation	22	8.1 Regular maintenance	40
7.2.2 Operating states	22	8.2 Cleaning	40
7.2.3 Sleep mode (energy-saving mode)	22	8.3 Service system	40
7.2.4 Overview of display symbols	23	8.4 Perform service	41
7.3 Main menus	24	8.4.1 Service overview	42
7.3.1 Operation	24	8.4.2 Dismantling the dosing head, diaphragm and valves	43
7.3.2 Info	24	8.4.3 Reassembling the dosing head, diaphragm and valves	43
		8.4.4 Replacing the deaeration valve	44
		8.4.5 Replacing the DLD sensor	44
		8.4.6 Replacing the mains cable	44

8.5	Resetting the service system	44
8.6	Diaphragm leakage	45
8.6.1	Dismantling the dosing head, diaphragm and valves in case of diaphragm leakage	45
8.6.2	Dosing liquid in the pump housing	45
8.7	Repairs	46
<b>9.</b>	<b>Faults</b>	<b>46</b>
9.1	List of faults	47
9.1.1	Faults with error message	47
9.1.2	General faults	50
<b>10.</b>	<b>Disposal</b>	<b>50</b>



Read this document before installing the product. Installation and operation must comply with local regulations and accepted codes of good practice.

## 1. General information

These installation and operating instructions contain general instructions that must be observed during installation, operation and maintenance of the pump. It must therefore be read by the installation engineer and the relevant qualified operator prior to installation and startup, and must be available at the installation location at all times.

### 1.1 Symbols used in this document

#### WARNING



Indicates a hazardous situation which, if not avoided, could result in death or serious personal injury.

#### CAUTION



Indicates a hazardous situation which, if not avoided, could result in minor or moderate personal injury.

The text accompanying the hazard symbols is structured in the following way:

#### SIGNAL WORD



##### Description of hazard

Consequence of ignoring the warning.  
- Action to avoid the hazard.



A blue or grey circle with a white graphical symbol indicates that an action must be taken.



If these instructions are not observed, it may result in malfunction or damage to the equipment.



Tips and advice that make the work easier.

## 1.2 Qualification and training

The persons responsible for the installation, operation and service must be appropriately qualified for these tasks. Areas of responsibility, levels of authority and the supervision of the persons must be precisely defined by the operator. If necessary, the persons must be trained appropriately.

### Risks of not observing the safety instructions

Non-observance of the safety instructions may have dangerous consequences for persons, the environment and the pump and may result in the loss of any claims for damages.

It may lead to the following hazards:

- Personal injury from exposure to electrical, mechanical and chemical influences.
- Damage to humans, animals and the environment from leakage of harmful substances.

## 1.3 Safety instructions for the operator/user

The safety instructions described in these instructions, existing national regulations on health protection, environmental protection and for accident prevention and any internal working, operating and safety regulations of the operator must be observed.

Information attached to the pump must be observed.

Leakages of dangerous substances must be disposed of in a way that is not harmful to humans, animals and the environment.

Damage caused by electrical energy must be prevented, see the regulations of the local electricity supply company.

#### WARNING



##### Electric shock

Death or serious personal injury  
- Keep liquids away from the power supply and electrical components.



Before starting work on the pump, the pump must be in the "Stop" operating state or be disconnected from the power supply. The system must be pressureless.



The mains plug is the separator separating the pump from the mains.

Only original accessories and original spare parts should be used.

## 1.4 Safety of the system in the event of a failure in the dosing pump

The dosing pump was designed according to the latest technologies and is carefully manufactured and tested.

If it fails regardless of this, the safety of the overall system must be ensured. Use the relevant monitoring and control functions for this.



Make sure that any chemicals that are released from the pump or any damaged lines do not cause damage to system parts and buildings.

The installation of leak monitoring solutions and drip trays is recommended.

## 1.5 Dosing chemicals

Before switching the supply voltage back on, the dosing lines must be connected in such a way that any chemicals in the dosing head cannot spray out and put people at risk.

The dosing medium is pressurised and can be harmful to health and the environment.

When working with chemicals, the accident prevention regulations applicable at the installation site should be applied (e.g. wearing protective clothing and safety goggles).

Observe the chemical manufacturer's safety data sheets and safety instructions when handling chemicals!

A deaeration hose, which is routed into a container, e.g. a drip tray, must be connected to the deaeration valve.

## 1.6 Diaphragm leakage

If the diaphragm leaks or is broken, dosing liquid escapes from the drain opening on the dosing head. See fig. 4, pos. 16. Observe section [8.6 Diaphragm leakage](#).

### WARNING

#### **Danger of explosion, if dosing liquid has entered the pump housing!**

Death or serious personal injury  
Operation with damaged diaphragms can lead to dosing liquid entering the pump housing.



- In case of diaphragm leakage, immediately separate the pump from the power supply!
- Make sure the pump cannot be put back into operation by accident!
- Dismantle the dosing head without connecting the pump to the power supply and make sure no dosing liquid has entered the pump housing. Proceed as described in section [8.6.1 Dismantling the dosing head, diaphragm and valves in case of diaphragm leakage](#).

To avoid any danger resulting from diaphragm leakage, observe the following:

- Perform regular maintenance. See section [8.1 Regular maintenance](#).
- Never operate the pump with blocked or soiled drain opening.
  - If the drain opening is blocked or soiled, proceed as described in section [8.6.1 Dismantling the dosing head, diaphragm and valves in case of diaphragm leakage](#).
- Take suitable precautions to prevent harm to health and damage to property from escaping dosing liquid.
- Never operate the pump with damaged or loose dosing head screws.

### 1.6.1 Diaphragm leakage detection (optional)

Applies to DDA-AR control variant.

Pumps with diaphragm leakage detection (DLD) have a special dosing head with a special diaphragm and a pressure switch. The pressure switch is fitted and connected to the pump on delivery.

For pumps with diaphragm leakage detection the pressure differential between inlet and outlet side must be at least 2 bar / 29 psi.

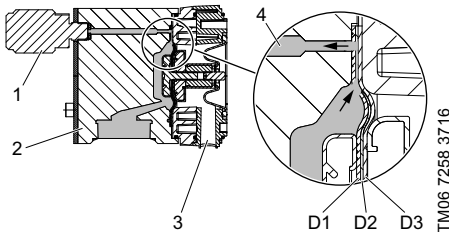

Fig. 1 Diaphragm leakage detection

Pos.	Components
1	Pressure switch
2	Dosing head
3	Drain opening
4	Dosing medium
D1	Working diaphragm
D2	Signal diaphragm (intermediate layer)
D3	Protective diaphragm

In case of a leak in the working diaphragm:

- Dosing medium (4) penetrates between working diaphragm (D1) and protective diaphragm (D3) and is transferred to the pressure switch (1) through the signal diaphragm (D2).
- On the next discharge stroke the increasing pressure activates the pressure switch (1).
- The pump indicates an alarm and stops.

The pump provides two relay outputs, which can be used to trigger an external alarm, for example.

Replace the diaphragm as soon as possible after a diaphragm leakage was detected.



Replace the pressure switch, if the diaphragm of the pressure switch is damaged.

If both the working diaphragm (D1) and the protective diaphragm (D3) are damaged, dosing liquid escapes from the drain opening (3) on the dosing head.



Immediately separate the pump from the power supply. Observe section [1.6 Diaphragm leakage](#).

## 2. Storage and handling

### 2.1 Storage

- Observe the permissible ambient conditions. See section [4. Technical data / Dimensions](#).
- The storage location must be protected from rain, humidity, condensation, direct sunlight and dust.
- The product must be drained completely.
- The product must be cleaned.

### 2.2 Unpacking

- Mount as soon as possible after unpacking.
- Observe the permissible ambient conditions. See section [4. Technical data / Dimensions](#).

### 2.3 Transport

- The product must only be transported by trained persons.
- Wear personal protective equipment.
- Observe the permissible ambient conditions. See section [4. Technical data / Dimensions](#).
- The product must be drained completely.
- The product must be cleaned.
- Use the original packaging or equivalent to protect the product during transport.
- Use appropriate lifting and transporting devices.
- Secure the product during transport to prevent it from tilting and moving.
- Avoid strong impact loads.
- If the pump is installed in a system during transport, make sure it is secured on the mounting plate with the 6 vertical safety screws. See section [5.1.3 Installing the pump on the mounting plate](#).

### 3. Product introduction

The DDA dosing pump is a self-priming diaphragm pump. It consists of a housing with PMS (Permanent Magnet Synchronous) motor and electronics, a dosing head with double PTFE diaphragm and valves, and the control cube.

Excellent dosing features of the pump:

- Optimal intake even with degassing media, as the pump always works at full suction stroke volume.
- Continuous dosing, as the medium is sucked up with a short suction stroke, regardless of the current dosing flow, and dosed with the longest possible dosing stroke.

#### 3.1 Applications

The pump is suitable for liquid, non-abrasive, non-flammable and non-combustible media. Observe the technical data of the product. See section [4.1 Technical data](#).

Observe the freezing and boiling points of the dosing medium.

Make sure that parts in contact with the dosing medium are resistant to the dosing medium under operating conditions. See data booklet:

- <http://net.grundfos.com/qr/i/99021865>.

Should you have any questions regarding the material resistance and suitability of the pump for specific dosing media, please contact Grundfos.

A sunscreen is required for outdoor installation.

#### Areas of application

- Drinking water treatment
- Wastewater treatment
- Boiler water treatment
- Cooling water treatment
- Process water treatment
- CIP (Clean-In-Place). Observe section [4.2 Technical data for CIP \(Clean-In-Place\) applications](#).
- Swimming pool water treatment
- Chemical industry
- Ultrafiltration process and reverse osmosis
- Food and beverage industry
- Paper and pulp industry
- Irrigation

### 3.2 Improper operating methods

The operational safety of the pump is only guaranteed if it is used in accordance with section [3.1 Applications](#).

Other applications or the operation of pumps in ambient and operating conditions, which are not approved, are considered improper and are not permitted. Grundfos cannot be held liable for any damage resulting from incorrect use.



The pump is NOT approved for operation in potentially explosive areas, automotive applications or marine applications.



Frequent disengagement from the mains voltage, e.g. via a relay, can result in damage to the pump electronics and in the breakdown of the pump. The dosing accuracy is also reduced as a result of internal start procedures.



Do not control the pump via the mains voltage for dosing purposes!

Only use the "External stop" function to start and stop the pump!



Only use the deaeration valve for deaerating the pump. Make sure the deaeration valve is closed during normal operation.

### 3.3 Symbols on the pump

Symbol	Description
	Indication of universally dangerous spot.
	In case of emergency and prior to all maintenance work and repairs, take the mains plug out of the power supply!
	The device complies with electrical safety class I.

### 3.4 Nameplate

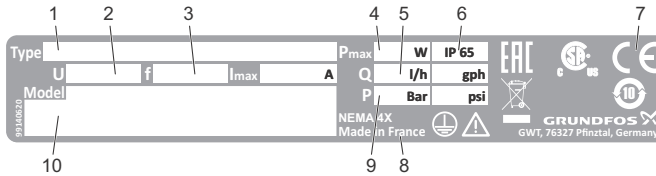

Fig. 2 Nameplate

Pos.	Description	Pos.	Description
1	Type designation	6	Enclosure class
2	Voltage	7	Marks of approval
3	Frequency	8	Country of origin
4	Power consumption	9	Max. operating pressure
5	Max. dosing flow	10	Model

TMM06 7046 3418

### 3.5 Type key

The type key is used to identify the precise pump and is not used for configuration purposes.

Example: **DDA 60-10 FCM-PVC/V/C-F-31U3U3FG**

#### Type

**DDA 60-10 FCM-PVC/V/C-F-31U3U3FG**

#### Max. flow [l/h]

**DDA 60-10 FCM-PVC/V/C-F-31U3U3FG**

#### Max. pressure [bar]

**DDA 60-10 FCM-PVC/V/C-F-31U3U3FG**

#### Control variant

**DDA 60-10 FCM-PVC/V/C-F-31U3U3FG**

AR Alarm relay

FCM AR + FlowControl function

#### Dosing head variant

**DDA 60-10 FCM-PVC/V/C-F-31U3U3FG**

PVC Polyvinyl chloride

PV PVDF

SS Stainless steel 1.4401

PVC-L PVC + integrated diaphragm leakage detection

PV-L PV + integrated diaphragm leakage detection

SS-L SS + integrated diaphragm leakage detection

#### Gasket material

**DDA 60-10 FCM-PVC/V/C-F-31U3U3FG**

E EPDM

V FKM

T PTFE

#### Valve ball material

**DDA 60-10 FCM-PVC/V/C-F-31U3U3FG**

C Ceramics

SS Stainless steel 1.4401

#### Control cube

**DDA 60-10 FCM-PVC/V/C-F-31U3U3FG**

F Front mounted (change to left or right is possible)

#### Supply voltage

**DDA 60-10 FCM-PVC/V/C-F-31U3U3FG**

3 100-240 V 50/60 Hz single phase

#### Valve type

**DDA 60-10 FCM-PVC/V/C-F-31U3U3FG**

1 Standard

2 Spring-loaded

#### Connection, inlet / outlet

**DDA 60-10 FCM-PVC/V/C-F-31U3U3FG**

U3U3 2x Union nut G5/4

2x Hose connector 19/20 mm

2x Hose clamp

2x Pipe connector 25 mm

A7A7 2x Union nut G5/4

2x Inlay external thread 3/4 NPT

A1A1 2x Union nut G5/4 (SS)

2x Inlay internal thread Rp3/4 (SS)

A3A3 2x Union nut G5/4 (SS)

2x Inlay internal thread 3/4 NPT (SS)

#### Mains plug

**DDA 60-10 FCM-PVC/V/C-F-31U3U3FG**

F EU (Schuko)

B USA, Canada

G UK

I Australia, New Zealand, Taiwan

E Switzerland

J Japan

L Argentina

#### Design

**DDA 60-10 FCM-PVC/V/C-F-31U3U3FG**

G Grundfos red

A Grundfos green

B Grundfos black

X Neutral / black

#### Special variant

**DDA 60-10 FCM-PVC/V/C-F-31U3U3FGC3**

Standard

C3 Inspection certificate 3.1 (EN 10204)



### 3.6 Product overview

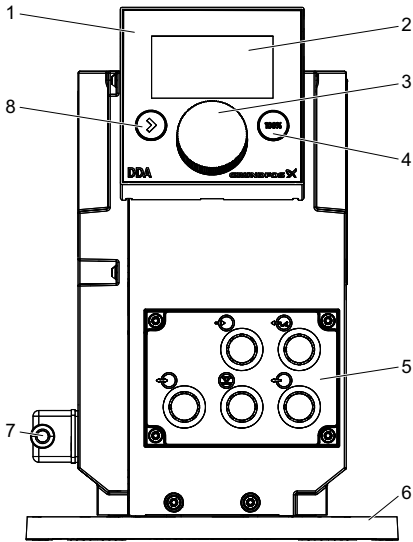

Fig. 3 Front view of the pump

TM06 7047 2916

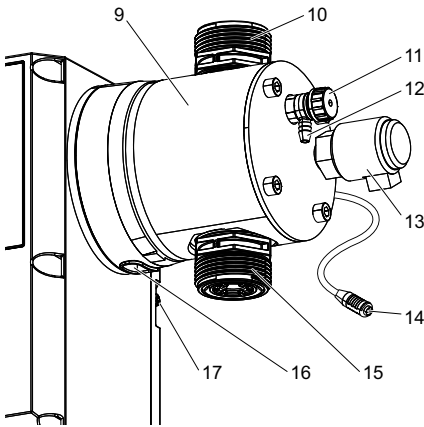

Fig. 4 Dosing head

TM06 7048 2916

Pos.	Description	See section
1	Control cube	
2	Graphic LC display	7.2.2
3	Click wheel	7.1
4	[100%] key	7.1
5	Signal inputs/outputs	5.3
6	Mounting plate	
7	Mains connection	
8	[Start/stop] key	7.1
9	Dosing head	
10	Valve, outlet side	
11	Deaeration valve	
12	Connection, deaeration hose	
13	Pressure switch of diaphragm leakage detection (optional for DDA-AR)	
14	FlowControl sensor plug (only DDA-FCM)	
15	Valve, inlet side	
16	Drain opening in case of diaphragm leakage	
17	Signal connection (FlowControl or diaphragm leakage detection)	

## 4. Technical data / Dimensions

### 4.1 Technical data

Data		60-10	120-7	200-4
Turn-down ratio (setting range)	[1:X]	800	800	800
Max. dosing capacity	[l/h]	60	120	200
	[gph]	15.8	32	52.8
Max. dosing capacity with SlowMode 50 %	[l/h]	30	60	100
	[gph]	7.9	16	26.4
Max. dosing capacity with SlowMode 25 %	[l/h]	15	30	50
	[gph]	3.95	8	13.2
Min. dosing capacity	[l/h]	0.075	0.15	0.25
	[gph]	0.0197	0.04	0.066
Max. operating pressure (backpressure)	[bar]	10	7	4
	[psi]	145	101	58
Max. stroke frequency <sup>1)</sup>	[strokes/ min]	196	188	188
Stroke volume	[ml]	5.56	11.58	19.3
Accuracy of repeatability <sup>5)</sup>	[%]	1.5 SP + 0.1 FS <sup>5)</sup>		
Max. suction lift during operation <sup>2)</sup>	[m]	3		
Max. suction lift when priming with wet valves <sup>2)</sup>	[m]	1.5		
Min. pressure difference between inlet and outlet side	[bar]	1 <sup>6)</sup>		
	[psi]	14.5 <sup>6)</sup>		
Max. inlet pressure, inlet side	[bar]	2		
	[psi]	29		
Max. viscosity in SlowMode 25 % with spring-loaded valves <sup>3)</sup>	[mPas] (= cP)	3000	3000	2000
Max. viscosity in SlowMode 50 % with spring-loaded valves <sup>3)</sup>	[mPas] (= cP)	2000	1500	1000
Max. viscosity without SlowMode with spring-loaded valves <sup>3)</sup>	[mPas] (= cP)	1000	1000	500
Max. viscosity without spring-loaded valves <sup>3)</sup>	[mPas] (= cP)	100		
Min. internal hose/pipe diameter inlet/outlet side <sup>2), 4)</sup>	[mm]	19		
Min. internal hose/pipe diameter inlet/outlet side (high viscosity) <sup>4)</sup>	[mm]	19		
Min. / Max. liquid temperature (PVDF, SS)	[°C]	0 / 50		
Min. / Max. liquid temperature (PVC)	[°C]	0 / 40		
Min. / Max. ambient temperature	[°C]	0 / 45		
Min. / Max. storage temperature (PVDF, SS)	[°C]	-20 / 70		
Min. / Max. storage temperature (PVC)	[°C]	-20 / 45		
Max. relative humidity (non-condensing)	[%]	90		
Max. altitude above sea level	[m]	2000		

**Mechanical data**

Data		60-10	120-7	200-4	
<b>Electrical data</b>	Voltage	[V]	100-240 V $\pm$ 10 %, 50/60 Hz		
	Length of mains cable	[m]	1.5		
	Max. inrush current for 2 ms (100 V)	[A]	35		
	Max. inrush current for 2 ms (240 V)	[A]	70		
	Max. power consumption P <sub>1</sub>	[W]	62		
	Enclosure class		IP65, Nema 4X		
	Electrical safety class		I		
	Pollution degree		2		
<b>Signal input</b>	Max. load for level input		12 V, 5 mA		
	Max. load for pulse input		12 V, 5 mA		
	Max. load for External stop input		12 V, 5 mA		
	Min. pulse length	[ms]	5		
	Max. pulse frequency	[Hz]	100		
	Impedance at 0/4-20 mA analog input	[ $\Omega$ ]	15		
	Accuracy of analog input (full-scale value)	[%]	$\pm$ 0.5		
	Min. resolution of analog input	[mA]	0.02		
<b>Signal output</b>	Max. loop resistance in external circuit	[ $\Omega$ ]	150		
	Max. resistive load on relay output	[A]	0.5		
	Max. voltage on relay/analog output	[V]	30 VDC / 30 VAC		
	Max. loop resistance in external circuit of the 0/4-20 mA analog output	[ $\Omega$ ]	500		
	Accuracy of analog output (full-scale value)	[%]	$\pm$ 0.5		
<b>Weight/size</b>	Min. resolution of analog output	[mA]	0.02		
	Weight (PVC, PVDF)	[kg]	6.7	7.9	8.9
	Weight (stainless steel)	[kg]	7.2	8.3	9.1
<b>Sound pressure</b>	Diaphragm diameter	[mm]	74	97	117
	Max. sound pressure level	[dB(A)]	80		
<b>Approvals</b>		CE, CSA-US, NSF61, EAC, ACS, RCM			

- 1) The maximum stroke frequency varies depending on calibration
- 2) Data is based on measurements with water
- 3) Maximum suction lift: 1 m, dosing capacity reduced (approx. 30 %)
- 4) Length of inlet line: 1.5 m, length of outlet line: 10 m (at max. viscosity)
- 5) FS = Full-scale (maximum actual dosing flow), SP = Setpoint
- 6) For FCM control variant and for pumps with diaphragm leakage detection the pressure difference must be at least 2 bar / 29 psi.

## 4.2 Technical data for CIP (Clean-In-Place) applications

Short-term temperature limits for max. 40 minutes at max. 2 bar operating pressure:

Max. liquid temperature for dosing head material PVDF	[°C]	85
Max. liquid temperature for dosing head material stainless steel	[°C]	120



The dosing head material Polyvinyl chloride (PVC) must not be used in CIP applications.

### 4.2.1 Dimensions

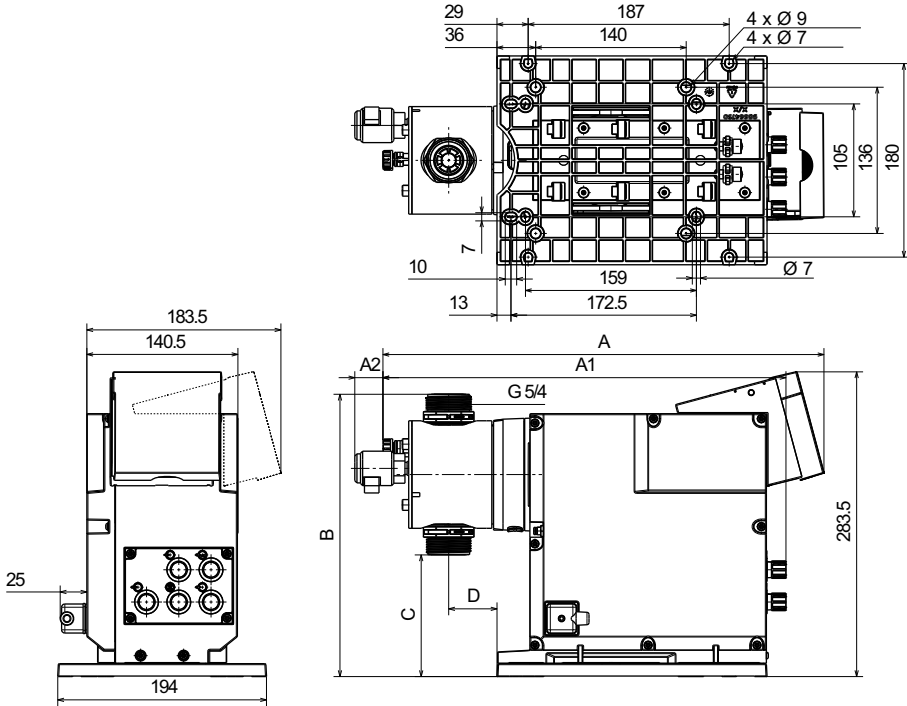

Fig. 5 Dimensional sketch

TM06 7049 3818

Pump type	Dosing head material	A [mm]	A1 [mm]	A2 [mm]	B [mm]	C [mm]	D [mm]
DDA 60-10	PVC/PV	410	374	26	263	112	45
DDA 60-10	SS	405	364	-	263	112	45
DDA 120-7	PVC/PV	410	374	26	276.5	97	45
DDA 120-7	SS	405	364	-	276.5	97	45
DDA 200-4	PVC/PV	410	374	26	287.5	88	45
DDA 200-4	SS	405	364	-	287.5	88	45

## 5. Assembly and installation

### 5.1 Pump assembly



Install the pump in such a way that the plug can easily be reached by the operator during operation. This will enable the operator to separate the pump from the power supply quickly in case of emergency.

#### 5.1.1 Requirements

- The installation location must be protected from rain, humidity, condensation, direct sunlight and dust.
- The installation location must have sufficient lighting to ensure safe operation.
- Observe the permissible ambient conditions. See section [4.1 Technical data](#).
- The mounting surface must be stable.
- The mounting plate must be mounted horizontally e.g. on a tank.
- Dosing must flow upwards vertically.

#### 5.1.2 Aligning and installing the mounting plate

The mounting plate can be used as a drill template, please see fig. [5](#) for drill hole distances.

1. Indicate drill holes.
2. Drill holes.
3. Secure mounting plate using four screws on a bracket or a tank.

#### 5.1.3 Installing the pump on the mounting plate

1. Remove the locking screws from their transport position on the mounting plate.
2. Place the pump on the mounting plate support clamps and slide it in as far as possible.
  - The mounting plate moves into the final position when you tighten the locking screws.
3. Carefully screw in and tighten the 2 horizontal locking screws using a torque wrench.
  - Wrench size: TORX PLUS 15 IP
  - Torque [Nm]: 1.7 (+/- 0.2)

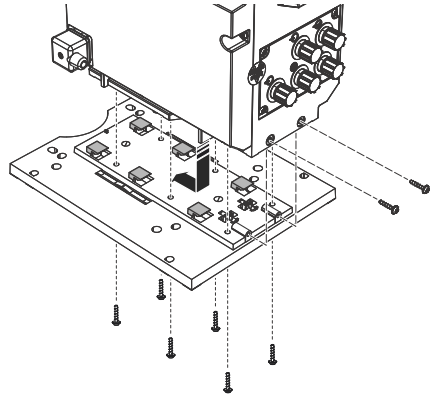

**Fig. 6** Installing the pump on the mounting plate

4. For applications where the mounting surface vibrates, or if the pump is installed in a system during transport, secure the pump on the mounting plate with the 6 vertical safety screws using a torque wrench.
  - Wrench size: TORX PLUS 15 IP
  - Torque [Nm]: 1.7 (+/- 0.2)

TM06 7050 3418

### 5.1.4 Adjusting the control cube position

The control cube is fitted to the front of the pump on delivery. It can be turned by 90 ° so that the user can select to operate the pump from the right or left side.



Install the control cube correctly to ensure the enclosure class (IP65 / Nema 4X) and shock protection.

1. Switch off the power supply.
2. Carefully remove both protective caps on the control cube using a thin screwdriver.
3. Remove the screws.
  - Wrench size: TORX PLUS 15 IP
4. Carefully lift off the control cube only so far from the pump housing that no tensile stress is produced on the flat band cable.
  - Make sure no liquid enters the housing.
5. Turn the control cube by 90 ° and re-attach.
  - Make sure the O-ring is placed correctly.
6. Push down the cube and tighten the screws using a torque wrench.
  - Torque [Nm]: 1.7 (± 0.2)
7. Attach the protective caps observing the correct orientation.

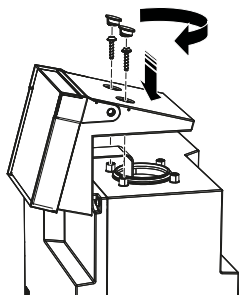
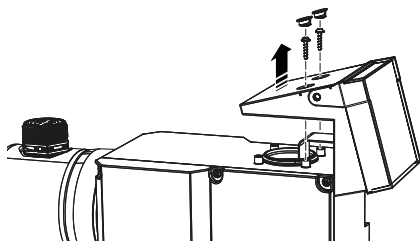

Fig. 7 Adjusting control cube

## 5.2 Hydraulic connection

### WARNING

#### Chemical hazard



Death or serious personal injury

- Observe the material safety data sheet of the dosing medium.
- Wear protective clothing (gloves and goggles) when working on the dosing head, connections or lines.

The dosing head may contain water from the factory check. When dosing media which should not come into contact with water, another medium must be dosed beforehand.

Faultless function can only be guaranteed in conjunction with lines supplied by Grundfos.

The lines used must comply with the pressure limits as per section 4.1 *Technical data*.

#### Important information on installation

- Observe suction lift and line diameter, see section 4.1 *Technical data*.
- Shorten hoses and pipes at right angles.
- Ensure that there are no loops or kinks in the hoses.
- Keep inlet line as short as possible.
- Route inlet line up towards the inlet valve.
- Installing a strainer in the inlet line protects the entire installation against dirt and reduces the risk of leakage.
- Install a pressure-relief valve in the outlet line to provide protection against impermissibly high pressure.
- We recommend the installation of a pulsation damper downstream the pump:
  - for pipe installations.
  - for hose installations where the pump is operated with  $\geq 75\%$  of its dosing capacity.
- Only control variant DDA-FCM and DDA with DLD:
  - For discharge quantities  $< 1$  l/h we recommend the use of an additional spring-loaded valve (approx. 2 bar) on the outlet side for the safe generation of the necessary differential pressure.

Pressure differential between inlet and outlet side must be at least 1 bar / 14.5 psi.



For control variant FCM and for pumps with diaphragm leakage detection the pressure differential between inlet and outlet side must be at least 2 bar / 29 psi.

TM06 7051 2916

### Hose connection, type U3U3

For details on connection types, see section [3.5 Type key](#).

1. Make sure the system is pressureless.
2. Push union nut (2) and hose clamp (3) across hose (4).
3. Push hose (4) completely onto hose connector (1) and tighten hose clamp (3).
4. Install hose connector (1) with union nut (2) at inlet and outlet valve.
  - Make sure the gasket at the valve is placed correctly.
  - Tighten union nuts manually. Do not use tools.
  - If using PTFE gaskets, retighten union nuts after 2-5 operating hours.
5. Attach a deaeration hose to the corresponding connection (see fig. 4, pos. 12) and run it into a suitable container or collecting tray.

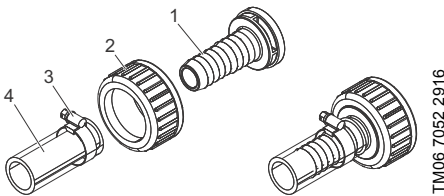
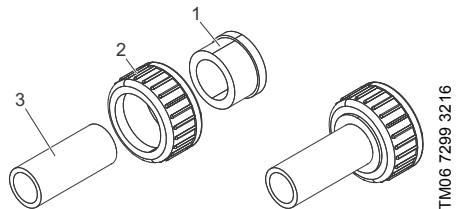

**Fig. 8** Hydraulic connection

### Pipe connection, type U3U3

For details on connection types, see section [3.5 Type key](#).

1. Make sure the system is pressureless.
2. Push union nut (2) across pipe (3).
3. For PVC pipe:  
Glue inlay (1) to end of pipe (3) according to pipe manufacturer's specification.
4. For PVDF pipe:  
Weld inlay (1) to end of pipe (3) according to pipe manufacturer's specification.
5. Install pipe with union nut (2) at inlet and outlet valve.
  - Make sure the gasket at the valve is placed correctly.
  - Tighten union nuts manually. Do not use tools.
  - If using PTFE gaskets, retighten union nuts after 2-5 operating hours.
6. Attach a deaeration hose to the corresponding connection (see fig. 4, pos. 12) and run it into a suitable container or collecting tray.

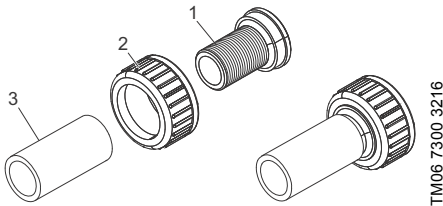

**Fig. 9** Hydraulic connection

### Pipe connection, types A1A1, A3A3, A7A7

For details on connection types, see section [3.5 Type key](#).

1. Make sure the system is pressureless.
2. Push union nut (2) across pipe (3).
3. Apply appropriate sealing material to thread of inlay (1).
4. Screw inlay (1) to end of pipe (3).
5. Install pipe with union nut (2) at inlet and outlet valve.
  - Make sure the gasket at the valve is placed correctly.
  - Tighten union nuts manually. Do not use tools.
  - If using PTFE gaskets, retighten union nuts after 2-5 operating hours.
6. Attach a deaeration hose to the corresponding connection (see fig. 4, pos. 12) and run it into a suitable container or collecting tray.



**Fig. 10** Hydraulic connection, type A7A7

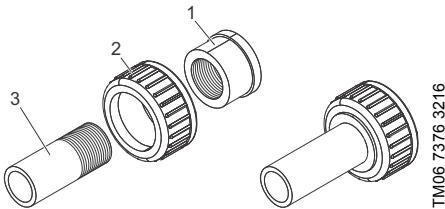

**Fig. 11** Hydraulic connection, type A1A1, A3A3

### 5.3 Electrical connection

The mains plug is the separator separating the pump from the mains.

All electrical connections must be carried out by a qualified electrician in accordance with local regulations.

The pump can start automatically when the power supply is switched on.

#### CAUTION



#### Automatic startup

Minor or moderate personal injury

- Make sure the pump has been correctly installed and is ready to be started before you switch on the power supply.

The enclosure class (IP65 / Nema 4X) is only guaranteed if plugs or protective caps are correctly installed.

Do not manipulate mains plug or cable.

The rated voltage of the pump must conform to local conditions. See section [3.4 Nameplate](#).



Signal connections

**WARNING**

**Electric shock**

Death or serious personal injury  
 - Electric circuits of external devices connected to the pump inputs must be separated from dangerous voltage by means of double or reinforced insulation!

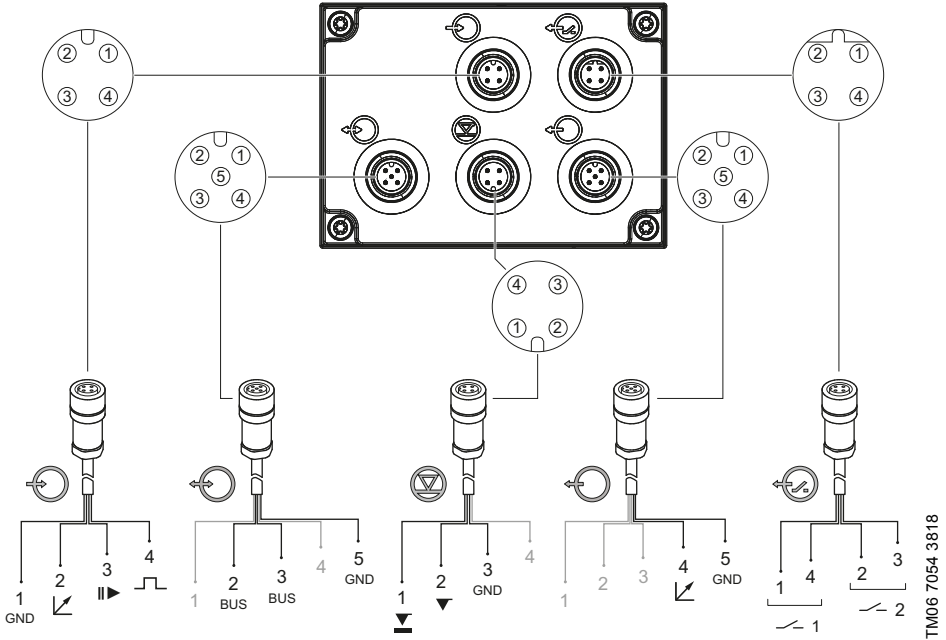
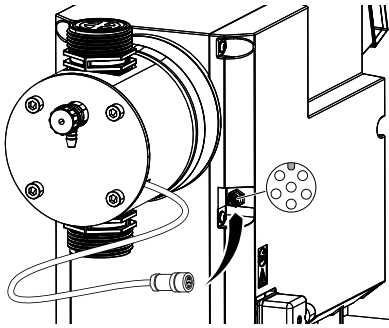

Fig. 12 Wiring diagram of the electrical connections

Symbol	Function	Pin assignment				
		1/brown	2/white	3/blue	4/black	
	Analog	GND/(-) mA		(+ ) mA		
	External stop	GND		X		
	Pulse	GND		X		
		1	2	3	4	
	Low-level signal	X		GND		
	Empty signal	X		GND		
		1/brown	2/white	3/blue	4/black	5/yellow/green
	Analog output			(+) mA		
				GND/(-) mA		
		1	2/brown	3/blue	4	5/black
	GENIbus	RS-485 A		RS-485 B		GND
		1/brown	2/white	3/blue	4/black	
	Relay 1	X		X		
	Relay 2	X		X		

## FlowControl signal connection (DDA-FCM)



TM06 7060 3716

Fig. 13 FlowControl signal connection

## DLD signal connection (optional for DDA-AR)

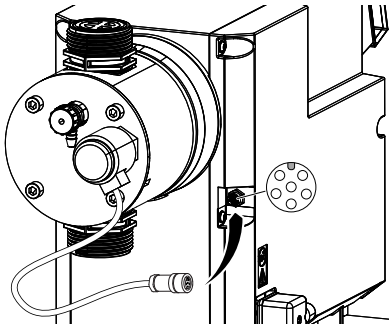

TM06 7256 3716

Fig. 14 DLD signal connection

## 6. Startup

## 6.1 Preparing the pump for startup

**CAUTION****Chemical hazard**

Minor or moderate personal injury

- Observe the material safety data sheet of the dosing medium.
- Wear protective clothing (gloves and goggles) when working on the dosing head, connections or lines.
- Collect and dispose of all chemicals in a way that is not harmful to humans, animals and the environment.



The pump can start automatically when the power supply is switched on.

**CAUTION****Automatic startup**

Minor or moderate personal injury

- Make sure the pump has been correctly installed and is ready to be started before you switch on the power supply.



Tighten the dosing head screws with a torque wrench before startup and every time the dosing head has been opened.

After 48 operating hours, retighten the dosing head screws using a torque wrench. Torque [Nm]: 6 (+ 1).



- Make sure the pump has been connected electrically by a qualified person.
- Make sure the power supply specified on the nameplate matches the local conditions.
- Check that all pipe or hose connections have been tightened properly and tighten them, if necessary. See section [5.2 Hydraulic connection](#).

## 6.2 Starting up the pump

1. Read section [6.1 Preparing the pump for startup](#).
2. Switch on the power supply.
3. Proceed according to sections:
  - [6.3 Setting the menu language](#)
  - [6.4 Deaerating the pump](#)
  - [6.5 Calibrating the pump](#).

### 6.3 Setting the menu language

For description of control elements, see section 7.

1. Turn click wheel to highlight the cog symbol.

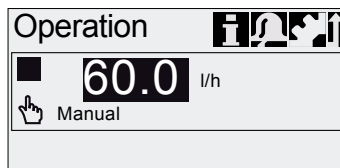

2. Press the click wheel to open the "Setup" menu.

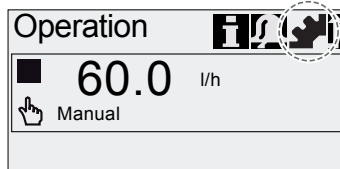

3. Turn the click wheel to highlight the "Language" menu.

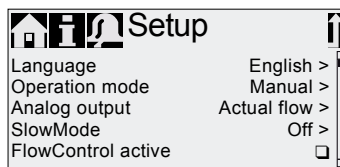

4. Press the click wheel to open the "Language" menu.

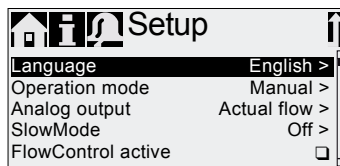

5. Turn the click wheel to highlight the desired language.

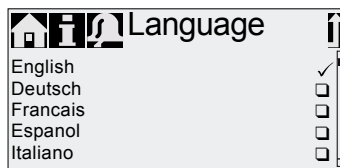

6. Press the click wheel to select the highlighted language.

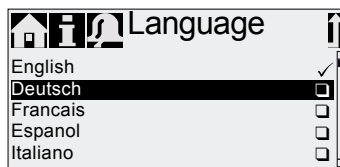

7. Press the click wheel again to confirm the "Confirm settings?" prompt and apply the setting.



Fig. 15 Set menu language

TM06 7061 2916

## 6.4 Deaerating the pump

1. Read section [6.1 Preparing the pump for startup](#).
2. Open the deaeration valve by approximately half a turn.

### WARNING



#### Pressurised dosing medium

Death or serious personal injury  
 - Do not open the deaeration valve by more than one full turn.

3. Press the [100%] key and hold it down until liquid flows out of the deaeration hose continuously and without any bubbles.
4. Close the deaeration valve.



Press the [100%] key and simultaneously turn the click wheel clockwise to increase the duration of the process to up to 300 seconds. After setting the seconds, do not press the key any longer.

## 6.5 Calibrating the pump

The pump is calibrated in the factory for media with a viscosity similar to water at maximum pump backpressure. See section [4.1 Technical data](#).

If the pump is operated with a backpressure that deviates or if dosing a medium whose viscosity deviates, the pump must be calibrated.

For pumps with FCM control variant, it is not necessary to calibrate the pump if there is deviating or fluctuating backpressure as long as the "AutoFlowAdapt" function has been enabled. See section [7.11 AutoFlowAdapt](#).



During calibration the pump performs 100 strokes/minute as a standard. If the SlowMode function is activated, the number of strokes/minute is 60 at 50 % and 30 at 25 %.

### Requirements

- The hydraulics and electrics of the pump are connected. See section [5. Assembly and installation](#).
- The pump is integrated into the dosing process under operating conditions.
- The dosing head and inlet line are filled with dosing medium.
- The pump has been deaerated.

**6.5.1 Calibration process - example for DDA 60-10**

1. Fill a measuring beaker with dosing medium.  
Recommended filling volumes  $V_1$ :
  - DDA 60-10: 2.5 l
  - DDA 120-7: 5 l
  - DDA 200-4: 8 l

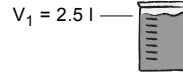

2. Read off and note down the fill volume  $V_1$  (e.g. 2.5 l).
3. Place the inlet line in the measuring beaker.

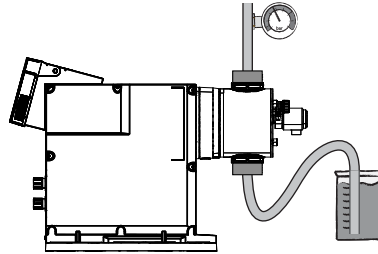

4. Start the calibration process in the "Setup > Calibration" menu.

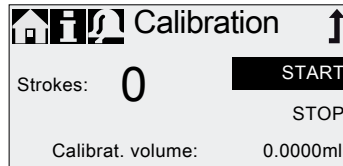

5. The pump executes 200 dosing strokes and displays the factory calibration value (e.g. 1.05 l).



6. Remove the inlet line from the measuring beaker and check the remaining volume  $V_2$  (e.g. 1.39 l).

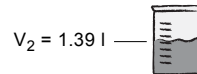

7. From  $V_1$  and  $V_2$ , calculate the actual dosed volume  $V_d = V_1 - V_2$  (e.g.  $2.5 \text{ l} - 1.39 \text{ l} = 1.11 \text{ l}$ ).

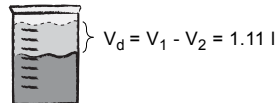

8. Set and apply  $V_d$  in the calibration menu.
  - The pump is calibrated.

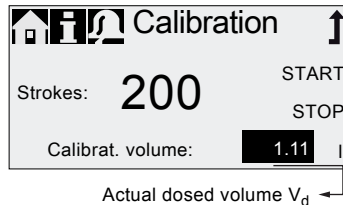

## 7. Operation

### 7.1 Control elements

The pump control panel includes a display and the following control elements.

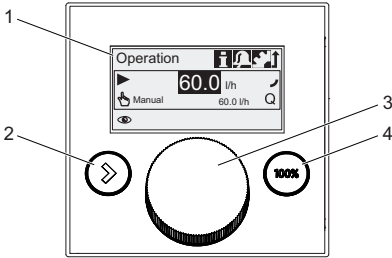

Fig. 16 Control panel

TM06 7063 3316

Pos.	Description
1	Graphical LC display
2	[Start/stop] key: Starting and stopping the pump.
3	Click wheel: The click wheel is used to navigate through the menus, select settings and confirm them. Turning the click wheel clockwise moves the cursor clockwise in increments in the display. Turning the click wheel counter-clockwise moves the cursor counter-clockwise.
4	[100%] key: The pump doses at maximum flow regardless of the operation mode.

## 7.2 Display and symbols

### 7.2.1 Navigation

In the "Info", "Alarm" and "Setup" main menus, the options and submenus are displayed in the rows below. Use the "Back" symbol to return to the higher menu level. The scroll bar at the right edge of the display indicates that there are further menu items which are not shown.

The active symbol (current cursor position) flashes. Press the click wheel to confirm your selection and open the next menu level. The active main menu is displayed as text, the other main menus are displayed as symbols. The position of the cursor is highlighted in black in the submenus.

When you position the cursor on a value and press the click wheel, a value is selected. Turning the click wheel clockwise increases the value, turning the click wheel counter-clockwise reduces the value. When you now press the click wheel, the cursor will be released again.

### 7.2.2 Operating states

The operating state of the pump is indicated by a symbol and display colour.

Display	Fault	Operating state		
White	-	Stop	Standby	
Green	-		Running	▶
Yellow	Warning	Stop	Standby	Running
Red	Alarm*	Stop	Standby	

\* For some alarms the pump tries to restart periodically. Observe section 9. *Faults*.

### 7.2.3 Sleep mode (energy-saving mode)

If in the "Operation" main menu the pump is not operated for 30 seconds, the header disappears. After two minutes, the display brightness is reduced.

If in any other menu the pump is not operated for two minutes, the display switches back to the "Operation" main menu and the display brightness is reduced. This state will be cancelled when the pump is operated or a fault occurs.

### 7.2.4 Overview of display symbols

The following display symbols may appear in the menus.

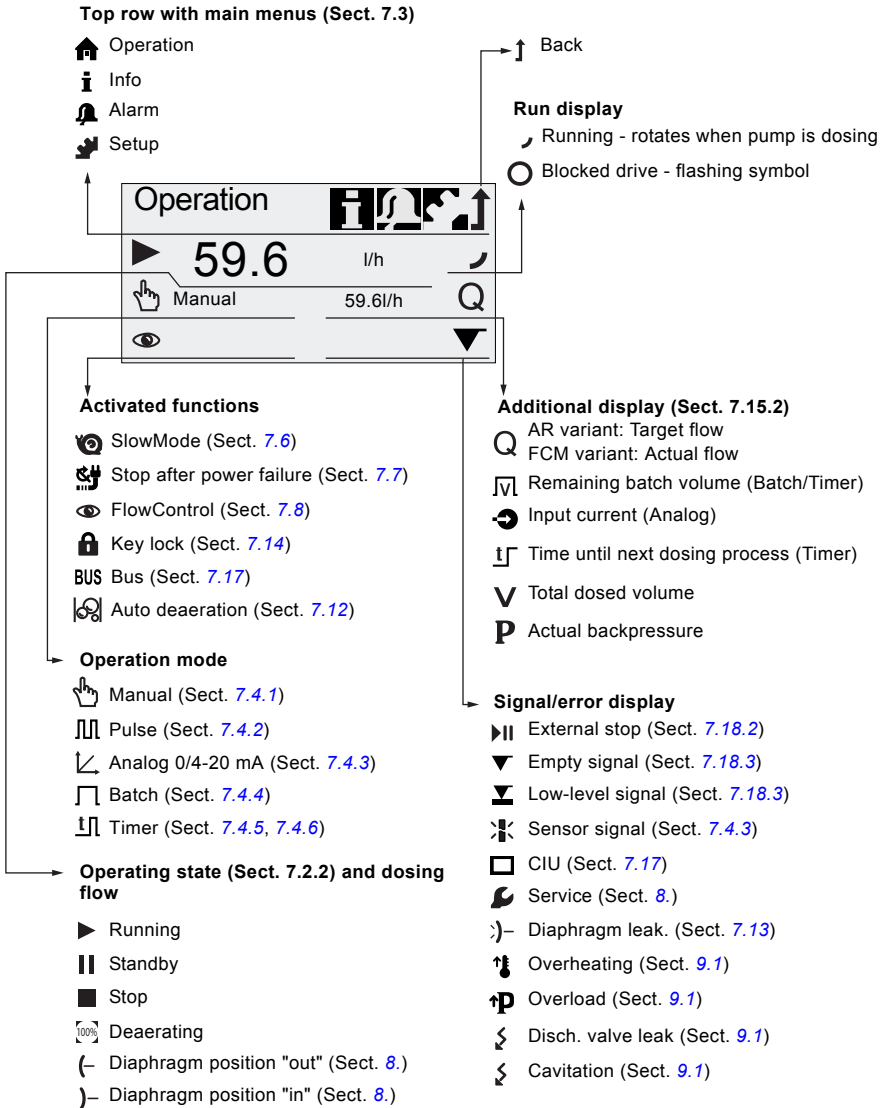

Fig. 17 Overview of display symbols

## 7.3 Main menus

The main menus are displayed as symbols at the top of the display. The currently active main menu is displayed as text.

### 7.3.1 Operation

Status information such as the dosing flow, selected operation mode and operating state is displayed in the "Operation" main menu.

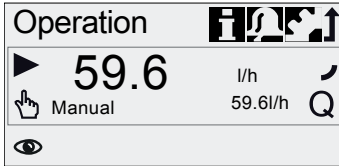

### 7.3.2 Info

You can find the date, time and information about the active dosing process, various counters, product data and the service system status in the "Info" main menu. The information can be accessed during operation.

The service system can also be reset from here.

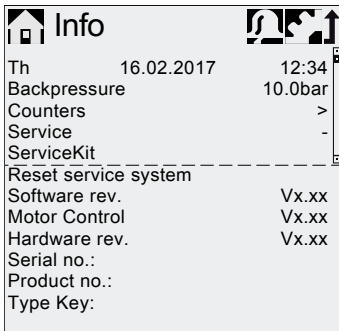

## Counters

The "Info > Counters" menu contains the following counters:

Counters	Resettable
<b>Volume</b>	
Total dosed volume [l] or US gallons	Yes
<b>Operating hours</b>	
Accumulated operating hours (pump switched on) [h]	No
<b>Motor runtime</b>	
Accumulated motor runtime [h]	No
<b>Strokes</b>	
Accumulated number of dosing strokes	No
<b>Power on/off</b>	
Accumulated frequency of switching mains voltage on	No

### 7.3.3 Alarm

You can view alarms and warnings in the "Alarm" main menu.

Some alarms are automatically acknowledged by opening the "Alarm" main menu, which can cause the pump to start.

#### CAUTION

##### Automatic startup



Minor or moderate personal injury

- Before entering the "Alarm" main menu, make sure the pump is in operating state "Stop".

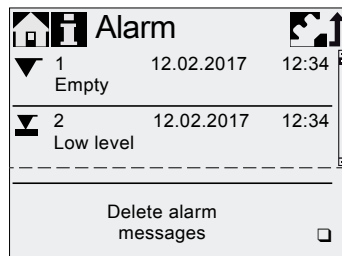

Up to 10 warnings and alarms, together with their date, time and cause, are listed in chronological order. If the list is full, the oldest entry will be overwritten, see section 9. *Faults*.



### 7.3.4 Setup

The "Setup" main menu contains menus for pump configuration. These menus are described in the following sections.

Check all pump settings after any change in the "Setup" menu.

	Section
Language	English > 6.3
Operation mode	Pulse > 7.4
Pulse memory*	<input type="checkbox"/> 7.4.2
Analog scaling	> 7.4.3
Batch volume*	35.0 l 7.4.4
Dosing time[mm:ss]*	46:30 7.4.4
Dosing timer cycle*	> 7.4.5
Dosing timer week*	> 7.4.6
Analog output	Actual flow > 7.5
SlowMode	Off > 7.6
Stop after power failure	<input type="checkbox"/> 7.7
FlowControl active*	<input type="checkbox"/> 7.8
FlowControl*	> 7.8
Pressure monitoring*	> 7.9
AutoFlowAdapt*	<input type="checkbox"/> 7.11
Auto deaeration	<input type="checkbox"/> 7.12
Calibration	> 6.5
Diaphragm leak. detect.*	<input type="checkbox"/> 7.13
Key lock	Off > 7.14
Display	> 7.15
Time+date	> 7.16
Bus	> 7.17
Inputs/Outputs	> 7.18
Basic settings	> 7.19

TM06 7075 3418

\* These submenus are only displayed for specific default settings and control variants. The contents of the "Setup" menu also vary depending on the operation mode.

### 7.4 Operation modes

Six different operation modes can be set in the "Setup > Operation mode" menu.

- Manual, see section 7.4.1
- Pulse, see section 7.4.2
- Analog 0-20mA, see section 7.4.3
- Analog 4-20mA, see section 7.4.3
- Batch (pulse-based), see section 7.4.4
- Dosing timer cycle, see section 7.4.5
- Dosing timer week, see section 7.4.6

#### 7.4.1 Manual

In this operation mode, the pump constantly doses the dosing flow set with the click wheel. The dosing flow is set in l/h or ml/h in the "Operation" menu. The pump automatically switches between the units. Alternatively, the display can be reset to US units (gph). See section 7.15 *Display setup*.

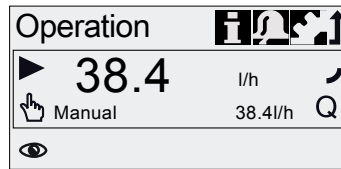

Fig. 18 Manual mode

The setting range depends on the pump type:

Type	Setting range*	
	[l/h]	[gph]
DDA 60-10	0.075 - 60	0.0197 - 15.8
DDA 120-7	0.15 - 120	0.04 - 32
DDA 200-4	0.25 - 200	0.066 - 52.8

\* When the "SlowMode" function is active, the maximum dosing flow is reduced, see section 4.1 *Technical data*.

TM06 7077 2916

### 7.4.2 Pulse

In this operation mode, the pump doses the set dosing volume for each incoming (potential-free) pulse, e.g. from a water meter. The pump automatically calculates the optimum stroke frequency for dosing the set volume per pulse.

The calculation is based on:

- the frequency of external pulses
- the set dosing volume/pulse.

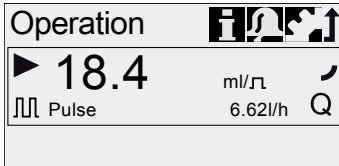

Fig. 19 Pulse mode

The dosing volume per pulse is set in ml/pulse in the "Operation" menu using the click wheel. The setting range for the dosing volume depends on the pump type:

Type	Setting range [ml/pulse]
DDA 60-10	0.0111 - 111
DDA 120-7	0.0232 - 232
DDA 200-4	0.0386 - 386

The frequency of incoming pulses is multiplied by the set dosing volume. If the pump receives more pulses than it can process at the maximum dosing flow, it runs at the maximum stroke frequency in continuous operation. Excess pulses will be ignored if the memory function is not enabled.

#### Memory function

When the "Setup > Pulse memory" function is enabled, up to 65,000 unprocessed pulses can be saved for subsequent processing.



Subsequent processing of saved pulses can cause local increase in concentration!

The contents of the memory will be deleted by:

- Switching off the power supply
- Changing the operation mode
- Interruption (e.g. alarm, External stop).



### 7.4.3 Analog 0/4-20 mA

In this operation mode, the pump doses according to the external analog signal. The dosing volume is proportional to the signal input value in mA.

Operation mode	Input value [mA]	Dosing flow [%]
4-20 mA	$\leq 4.1$	0
	$\geq 19.8$	100
0-20 mA	$\leq 0.1$	0
	$\geq 19.8$	100

If the input value exceeds 22 mA, an alarm is displayed and the pump stops dosing. If the input value in operation mode 4-20 mA falls below 2 mA, an alarm is displayed and the pump stops dosing. The "Sensor signal" alarm symbol is displayed in the "Signal and error display" area of the display.

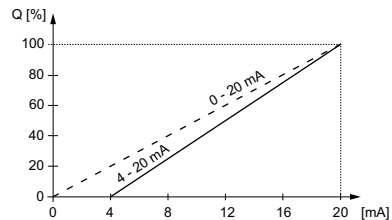

Fig. 20 Analog scaling

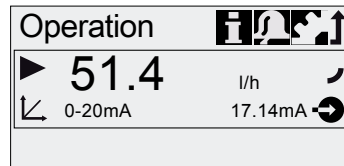

Fig. 21 Analog operation mode

TM06 7078 2916

TM06 7079 2916

TM06 7080 2916

**Set analog scaling**

Analog scaling refers to the assignment of the current input value to the dosing flow.

Changes of analog scaling affect also the analog output signal. See section 7.5 Analog output.

Analog scaling passes through the two reference points ( $I_1/Q_1$ ) and ( $I_2/Q_2$ ), which are set in the "Setup > Analog scaling" menu. The dosing flow is controlled according to this setting.

**Example 1 (DDA 60-10)**

Analog scaling with positive gradient:

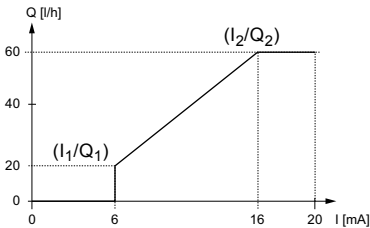

**Fig. 22** Analog scaling with pos. gradient

In example 1, the reference points  $I_1 = 6$  mA,  $Q_1 = 20$  l/h and  $I_2 = 16$  mA,  $Q_2 = 60$  l/h have been set.

From 0 to 6 mA analog scaling is described by a line that passes through  $Q = 0$  l/h, between 6 mA and 16 mA it rises proportionally from 20 l/h to 60 l/h and from 16 mA onwards it passes through  $Q = 60$  l/h.

**Example 2 (DDA 60-10)**

Analog scaling with negative gradient (Operation mode 0-20 mA):

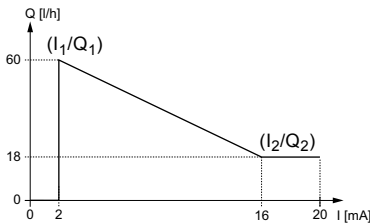

**Fig. 23** Analog scaling with neg. gradient

In example 2, the reference points  $I_1 = 2$  mA,  $Q_1 = 60$  l/h and  $I_2 = 16$  mA,  $Q_2 = 18$  l/h have been set.

From 0 to 2 mA analog scaling is described by a line that passes through  $Q = 0$  l/h, between 2 mA and 16 mA it drops proportionally from 60 l/h to 18 l/h and from 16 mA onwards it passes through  $Q_2 = 18$  l/h.

**Set analog scaling in the "Operation" menu**

Analog scaling can also be modified after a security prompt directly in the "Operation" menu. This is how the dosing flow is directly modified for the current flow input value. Please observe that changes also have a direct effect on point  $I_2/Q_2$  (see fig. 24).

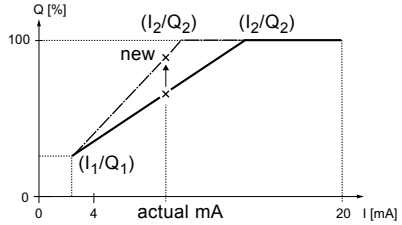

**Fig. 24** Set analog scaling ("Operation" menu)

**7.4.4 Batch (pulse-based)**

In this operation mode, the pump doses the set batch volume in the set dosing time ( $t_1$ ). A batch is dosed with each incoming pulse.

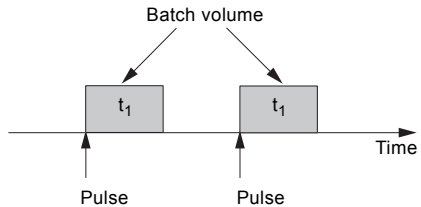

**Fig. 25** Batch (pulse-based)

The setting range depends on the pump type:

Type	Setting range per batch		Resolution* [ml]
	from [ml]	to [l]	
DDA 60-10	5.56	999	0.694
DDA 120-7	11.6	999	1.45
DDA 200-4	19.3	999	2.41

\* Thanks to the digital motor control, dosing quantities with a resolution of up to 1/8 of the dosing stroke volume can be dosed.

TM06 7083 2916

TM06 7081 3216

TM06 7085 3918

TM06 7082 3216

The batch volume (e.g. 75.0 l) is set in the "Setup > Batch volume" menu. The minimum dosing time required for this (e.g. 1 hour, 16 minutes) is displayed and can be increased.

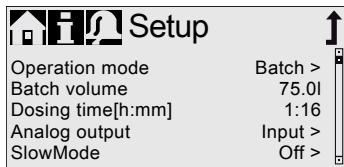

Fig. 26 Batch mode

Signals received during a batch process or an interruption (e.g. alarm, External stop) will be ignored. If the pump is restarted following an interruption, the next batch volume is dosed on the next incoming pulse.

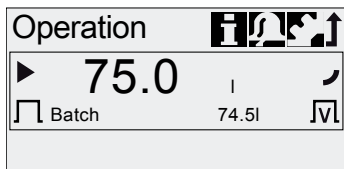

Fig. 27 Batch mode

In the "Operation" menu, the total batch volume (e.g. 75.0 l) and the remaining batch volume still to be dosed (e.g. 74.5 l) are shown in the display.

### 7.4.5 Dosing timer cycle



In this operation mode, the pump doses the set batch volume in regular cycles. Dosing starts when the pump is started after a singular start delay. The setting range for the batch volume corresponds to the values in section 7.4.4 *Batch (pulse-based)*.



When time or date is changed in "Time+date" menu, timer dosing and timer relay output functions (Relay 2) are stopped!

Timer dosing and timer relay output functions must be restarted manually!  
Changing time or date can cause increase or decrease in concentration!

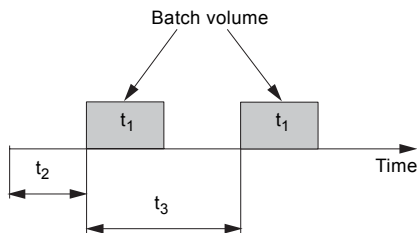

Fig. 28 Dosing timer cycle diagram

$t_1$	Dosing time
$t_2$	Start delay
$t_3$	Cycle time

In the event of an interruption (e.g. interruption of the mains voltage, External stop), the dosing will be stopped while the time continues running. After suspending the interruption, the pump will continue to dose according to the actual timeline position.

The following settings are required in the "Setup > Dosing timer cycle" menu:

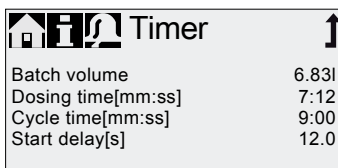

Fig. 29 Dosing timer cycle

The batch volume to be dosed (e.g. 6.83 l) is set in the "Setup > Dosing timer cycle" menu. The dosing time required for this (e.g. 7:12) is displayed and can be changed.

The total batch volume (e.g. 6.83 l) and the remaining batch volume still to be dosed are displayed in the "Operation" menu. During breaks in dosing, the time until the next dosing process (e.g. 11 seconds) is displayed.

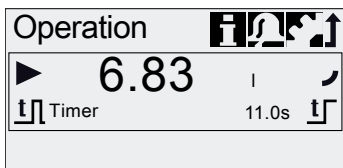

Fig. 30 Dosing timer cycle

TM06 7091 2916

### 7.4.6 Dosing timer week

In this operation mode, up to 16 dosing procedures are defined for a week. These dosing procedures may take place regularly on one or several week days. The setting range for the batch volume corresponds to the values in section [7.4.4 Batch \(pulse-based\)](#).



When time or date is changed in "Time+date" menu, timer dosing and timer relay output functions (Relay 2) are stopped!



Timer dosing and timer relay output functions must be restarted manually!

Changing time or date can cause increase or decrease in concentration!

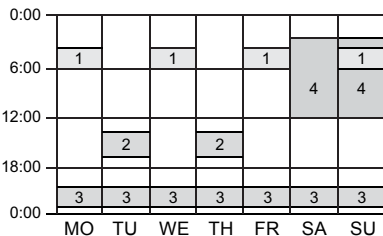

Fig. 31 Example for Dosing timer week function

TM06 7092 2916

If several procedures overlap, the process with the higher dosing flow has priority.

In the event of an interruption (e.g. disconnection of the mains voltage, External stop), the dosing is stopped while the time continues running. After suspending the interruption, the pump continues to dose according to the actual timeline position.

The following settings are required in the "Setup > Dosing timer week" menu for each dosing procedure:



Fig. 32 Setting the timer

TM06 7093 2916

The batch volume (e.g. 986 ml) is set in the "Setup > Dosing timer week" menu. The dosing time required for this (e.g. 1 minute, 0 seconds) is displayed and can be changed.

In the "Operation" menu, the total batch volume (e.g. 986 ml) and the remaining batch volume to be dosed is displayed. During breaks in dosing, the time (e.g. 1 day, 2 hours) until the next dosing is displayed.

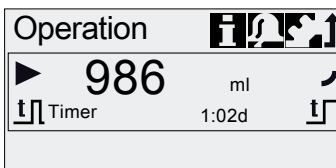

Fig. 33 Weekly timer dosing (break in dosing)

TM06 7091 2916

## 7.5 Analog output

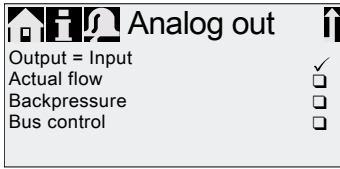

Fig. 34 Configure analog output

The analog output of the pump is parametrised in the "Setup > Analog output" menu. The following settings are possible:

Setting	Description of output signal	Variant	
		FCM	AR
Output = Input	Analog feedback signal (not for master-slave application). The analog input signal is mapped 1:1 to the analog output.	X	X
Actual flow**	Current actual flow • 0/4 mA = 0 % • 20 mA = 100 % see section <a href="#">7.10 Flow measurement</a>	X	X*
Backpressure	Backpressure, measured in the dosing head • 0/4 mA = 0 bar • 20 mA = Max. operating pressure see section <a href="#">7.9 Pressure monitoring</a>	X	
Bus control	Enabled by command in Bus control, see section <a href="#">7.17 Bus communication</a>	X	X

\* Output signal is based on motor speed and pump status (target flow).

\*\* Signal has same analog scaling as the current analog input signal. See [7.4.3 Analog 0/4-20 mA](#).

Wiring diagram see section [5.3 Electrical connection](#).



In all operation modes, the analog output has a range of 4-20 mA. Exception: Operation mode 0-20 mA. Here, the analog output range is 0-20 mA.

TM06 7094 2916

## 7.6 SlowMode



When the "SlowMode" function is enabled, the pump slows down the suction stroke. The function is enabled in the "Setup > SlowMode" menu and is used to prevent cavitation in the following cases:

- for dosing media with a high viscosity
- for degassing dosing media
- for long inlet lines
- for large suction lift.

In the "Setup > SlowMode" menu, the speed of the suction stroke can be reduced to 50 % or 25 %.



Enabling the 'SlowMode' function reduces the maximum dosing flow of the pump to the set percentage value!

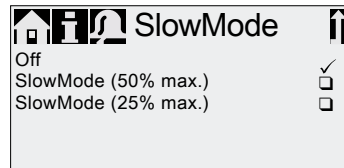

Fig. 35 SlowMode menu

TM06 7094 2916

## 7.7 Stop after power failure



This function is only available in pumps with software version V2.00 or higher.

The "Stop after power failure" function is used to prevent the pump from performing a reference movement and start dosing when the power supply is switched on or reestablished after a power failure.

A reference movement is performed every time the power supply is switched on. With the reference movement the pump identifies the exact diaphragm position to ensure accurate dosing. Depending on the initial diaphragm position, the reference movement can dose a small amount of dosing medium into the process. To avoid this, you can enable the "Stop after power failure" function.

The function is disabled by default.

When this function is enabled:

- The pump stops and displays an alarm when the power supply is switched on. The pump will perform the reference movement after the alarm was acknowledged by the user.
- Functions which require the reference movement are deactivated until the reference movement was performed. These functions are:
  - Auto deaeration
  - FlowControl
  - Moving the diaphragm into service position
  - Volume counter

To avoid dosing during the reference movement, perform the following steps after the power supply was switched on:

1. The pump is in operating state "Standby" and displays an alarm. Push the [Start/stop] key to set the pump to operating state "Stop".
2. Make sure a deaeration hose, which is routed into a container, e.g. a drip tray, is connected to the deaeration valve.
3. Open the deaeration valve by approximately half a turn.
4. Acknowledge the alarm on the display.
  - The pump performs the reference movement. The dosing medium flows through the deaeration hose and not into the process.
5. Close the deaeration valve.
6. Push the [Start/stop] key to start the pump.

## 7.8 FlowControl



Applies to DDA-FCM control variant.

This function is used to monitor the dosing process. Although the pump is running, various influences e.g. air bubbles, can cause a reduced flow or even stop the dosing process. In order to guarantee optimum process safety, the enabled "FlowControl" function directly detects and indicates the following errors and deviations:

- Overpressure
- Damaged outlet line
- Air in the dosing chamber
- Cavitation
- Inlet valve leakage > 70 %
- Outlet valve leakage > 70 %.

The occurrence of a fault is indicated by the "eye" symbol flashing. The faults are displayed in the "Alarm" menu. See section 9. [Faults](#).

FlowControl works with a maintenance-free sensor in the dosing head. During the dosing process, the sensor measures the current pressure and continuously sends the measured value to the microprocessor in the pump. An internal indicator diagram is created from the current measured values and the current diaphragm position (stroke length). Causes for deviations can be identified immediately by aligning the current indicator diagram with a calculated optimum indicator diagram. Air bubbles in the dosing head reduce e.g. the discharge phase and consequently the stroke volume (see fig. 36).

**Requirements for a correct indicator diagram are:**

- FlowControl function is active
- Pressure difference between inlet and outlet side is > 2 bar
- No interruption/pause in discharge stroke
- Pressure sensor and cable are functioning properly
- No leakage > 50 % in inlet or outlet valve

If one of these requirements is not met, the indicator diagram cannot be evaluated.

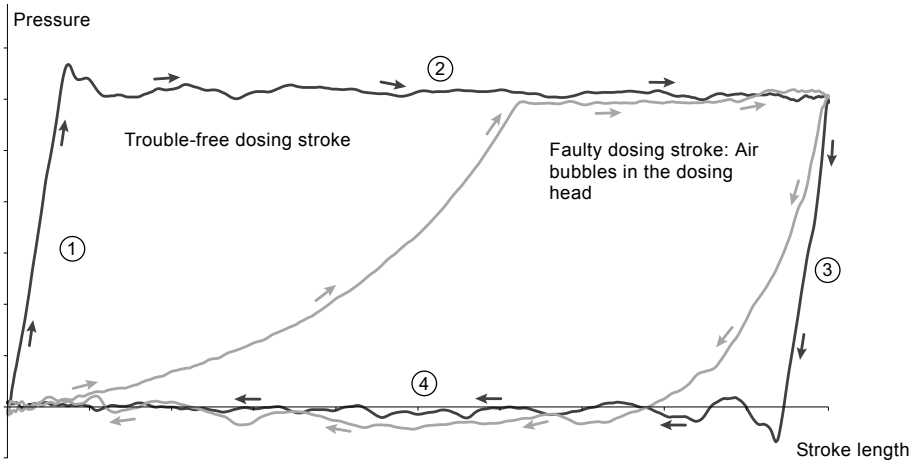

TM06 7097 2916

**Fig. 36** Indicator diagram

1	Compression phase
2	Discharge phase
3	Expansion phase
4	Suction phase

### Setting FlowControl

The "FlowControl" function is set using the two parameters "Sensitivity" and "Delay" in the "Setup > FlowControl" menu.

### Sensitivity

In "Sensitivity" the deviation in stroke volume, which will result in an error message, is set in percent.

Sensitivity	Deviation
low	approx. 70 %
medium	approx. 50 %
high	approx. 30 %



**Delay**

The "Delay" parameter is used to define the time period until an error message is generated: "short", "medium" or "long". The delay depends on the set dosing flow and therefore cannot be measured in strokes or time.

**Air bubbles**

The "FlowControl" function identifies air bubbles > 60 % of the stroke volume. The pump adapts the stroke frequency to approximately 30-40 % of max. stroke frequency, and starts a special motor drive strategy. The adaptation of the stroke frequency allows the air bubbles to rise from inlet to outlet valve. Due to the special motor drive strategy the air bubbles are displaced from the dosing head into the outlet line.

If the air bubbles have not been eliminated after a maximum of 60 strokes, the pump returns to the normal motor drive strategy and displays the "Air bubble" warning.

**7.9 Pressure monitoring**

*Applies to DDA-FCM control variant.*

A pressure sensor monitors the pressure in the dosing head. If the pressure during the discharge phase falls below 2 bar, a warning is generated (pump continues running). If in the "Setup > Pressure monitoring" menu the function "Min. pressure alarm" is activated, an alarm is generated and the pump is stopped.

If the pressure exceeds the "Max. pressure" set in the "Setup > Pressure monitoring" menu, the pump stops dosing, switches to operating state "Standby" and indicates an alarm.

**!** The pump restarts automatically once the backpressure falls below the set "Max. pressure"!

**7.9.1 Pressure setting ranges**

Type	Fixed min. pressure		Adjustable max. pressure	
	[bar]	[psi]	[bar]	[psi]
DDA 60-10	2	29	3-11	44-165
DDA 120-7	2	29	3-8	44-115
DDA 200-4	2	29	3-5	44-73

The pressure measured in the dosing head is slightly higher than the actual system pressure.



Therefore the "Max. pressure" should be set at least 1 bar higher than the system pressure.

**7.9.2 Calibration of pressure sensor**

The pressure sensor is calibrated in the factory. As a rule, it does not need to be re-calibrated. If specific circumstances (e.g. pressure sensor exchange, extreme air pressure values at the location of the pump) necessitate a calibration, the sensor can be calibrated as follows:

1. Set pump to "Stop" operating state.
2. Make system pressureless and flush.
3. Dismantle inlet line and inlet valve.

**!** Calibrating when the inlet valve is installed produces incorrect calibration and can cause personal injuries and damage to property!

Only carry out a calibration if this is technically required!

4. Proceed as described below to calibrate:

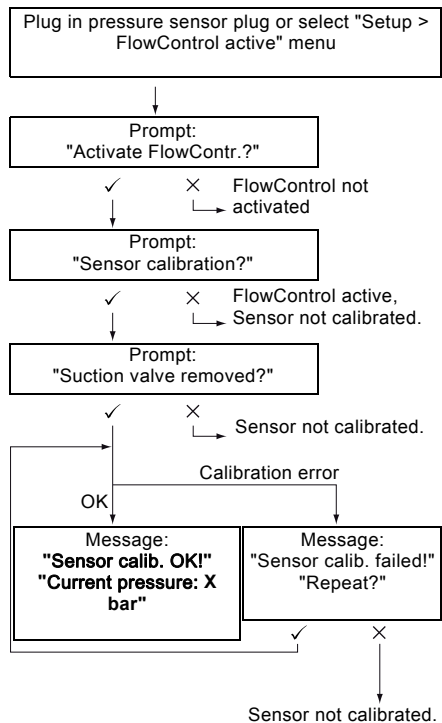

If a calibration is not successfully possible, check plug connections, cable and sensor and replace defective parts where necessary.

TM06 7098 29/16

## 7.10 Flow measurement

*Applies to DDA-FCM control variant.*

The pump accurately measures the actual flow and displays it. Via the 0/4-20 mA analog output, the actual flow signal can easily be integrated into an external process control without additional measuring equipment. See section [7.5 Analog output](#).

The flow measurement is based on the indicator diagram as described in section [7.8 FlowControl](#). The accumulated length of the discharge phase multiplied by the stroke frequency produces the displayed actual flow. Faults e.g. air bubbles or backpressure that is too low result in a smaller or larger actual flow. When the "AutoFlowAdapt" function is activated (see section [7.11 AutoFlowAdapt](#)), the pump compensates for these influences by correction of the stroke frequency.

Strokes which cannot be analysed (partial strokes, pressure differential which is too low) are provisionally calculated based on the setpoint value and displayed.

## 7.11 AutoFlowAdapt

*Applies to DDA-FCM control variant.*

The "AutoFlowAdapt" function can be activated via the "Setup" menu. It detects changes in various parameters and responds accordingly in order to keep the set target flow constant.



Dosing accuracy is increased when "AutoFlowAdapt" is activated.

This function processes information from the pressure sensor in the dosing head. The pump responds immediately regardless of the operation mode by adjusting the stroke frequency.

If the target flow cannot be achieved by the adjustments, a warning is issued.

"AutoFlowAdapt" operates on the basis of the following functions:

- FlowControl: malfunctions are identified. See section [7.8 FlowControl](#).
- Pressure monitoring: pressure fluctuations are identified. See section [7.9 Pressure monitoring](#).
- Flow measurement: deviations from the target flow are identified. See section [7.10 Flow measurement](#).

## Example of "AutoFlowAdapt"

### Pressure fluctuations

The dosing volume decreases as backpressure increases and conversely the dosing volume increases as the backpressure decreases.

The "AutoFlowAdapt" function compensates pressure fluctuations by adjusting the stroke frequency. The actual flow is thus maintained at a constant level.

## 7.12 Auto deaeration

Dosing degassing media can result in air pockets in the dosing head during breaks in dosing. This can result in no medium being dosed when restarting the pump. The "Setup > Auto deaeration" function performs pump deaeration automatically at regular intervals. Software-controlled diaphragm movements encourage any bubbles to rise and gather at the outlet valve so that they can be removed on the next dosing stroke.

The function works:

- when the pump is not in the "Stop" operating state and no alarm is active
- during breaks in dosing (e.g. External stop, no incoming pulses, etc.).

The diaphragm movements can displace small volumes into the outlet line. When dosing strongly degassing media, this is however virtually impossible.

## 7.13 Diaphragm leak. detect.

*Applies to DDA-AR control variant.*

This function is only available if the pump is equipped with a special dosing head for leakage detection. See section [3.5 Type key](#).

The "Diaphragm leak. detect." function can be activated via the "Setup" menu. It detects diaphragm leakages. When a leakage is detected, the pump stops and an alarm is displayed.

See also sections:

- [1.6.1 Diaphragm leakage detection \(optional\)](#)
- [7.2.4 Overview of display symbols](#)
- [9.1 List of faults](#)

## 7.14 Key lock



The key lock is set in the "Setup > Key lock" menu by entering a four-digit code. It protects the pump by preventing changes to settings. Two levels of key lock can be selected:

Level	Description
Settings	All settings can only be changed by entering the lock code. The [Start/stop] key and the [100%] key are not locked.
Settings + keys	The [Start/stop] key and the [100%] key and all settings are locked.

It is still possible to navigate in the "Alarm" and "Info" main menu and reset alarms.

### 7.14.1 Temporary deactivation

If the "Key lock" function is activated but settings need to be modified, the keys can be unlocked temporarily by entering the deactivation code. If the code is not entered within 10 seconds, the display automatically switches to the "Operation" main menu. The key lock remains active.

### 7.14.2 Deactivation

The key lock can be deactivated in the "Setup > Key lock" menu via the "Off" menu point. The key lock is deactivated after the general code "2583" or a pre-defined custom code has been entered.

## 7.15 Display setup

Use the following settings in the "Setup > Display" menu to adjust the display properties:

- Units (metric/US)
- Display contrast
- Additional display.

### 7.15.1 Units

Metric units (litres/millilitres/bar) or US units (US gallons/PSI) can be selected. According to the operation mode and menu, the following units of measurement are displayed:

Operation mode / function	Metric units	US units
Manual control	ml/h or l/h	gph
Pulse control	ml/□	ml/□
0/4-20 mA Analog control	ml/h or l/h	gph
Batch (pulse- or timer-controlled)	ml or l	gal
Calibration	ml	ml
Volume counter	l	gal
Pressure monitoring	bar	psi

### 7.15.2 Additional display

The additional display provides additional information about the current pump status. The value is shown in the display with the corresponding symbol.

In "Manual" mode the "Actual flow" information can be displayed with Q = 31.9 l/h (see fig. 37).

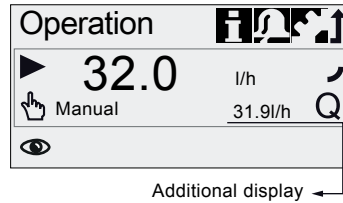

Fig. 37 Display with additional display

The additional display can be set as follows:

Setting	Description
	Depending on the operation mode:
	Q Actual flow (Manual/Pulse) <sup>1), 2)</sup>
Default display	Q Target flow (Pulse)
	↻ Input current (analog)
	□ Remaining batch volume (Batch, Timer)
	⏸ Period until next dosing (Timer)
Dosed volume	V Dosed vol. since last reset (see <a href="#">Counters</a> on page 24)
Actual flow	Q Current actual flow <sup>1), 2)</sup>
Backpressure	P Current backpressure in the dosing head <sup>1)</sup>

<sup>1)</sup> only control variant DDA-FCM

<sup>2)</sup> only if indicator diagram can be evaluated (see [7.8 FlowControl](#))

TMM06 7-103 2916

## 7.16 Time+date

The time and date can be set in the "Setup > Time+date" menu.

The conversion between summer and winter time does not take place automatically.

When time or date is changed in "Time+date" menu, timer dosing and timer relay output functions (Relay 2) are stopped!



Timer dosing and timer relay output functions must be restarted manually!

Changing time or date can cause increase or decrease in concentration!

## 7.17 Bus communication

The bus communication enables remote monitoring and setting of the pump via a fieldbus system.

Further manuals, functional profiles and support files (e.g. GSD-files) are available on the CD delivered with the interface hardware and on [www.grundfos.com](http://www.grundfos.com).

### 7.17.1 GENIbus communication

The pump is supplied with an integrated module for GENIbus communication. The pump identifies the bus control after connecting to the corresponding signal input. The "Activate communication?" prompt is displayed. After confirmation, the corresponding symbol appears in the "Activated functions" area in the "Operation" menu.

In the "Setup > Bus" menu the GENIbus address can be set from 32 to 231 and bus control can be deactivated.



Fig. 38 Bus menu

## BUS

## 7.17.2 Possible industrial bus types

The pump can be connected to a Grundfos CIU unit (CIU = Communication Interface Unit) equipped with one of the following CIM modules (CIM = Communication Interface Module):

- CIM150 Profibus
- CIM200 Modbus
- CIM260 3G/4G/SMS
- CIM280 3G/4G/GRM/GIC
- CIM500 Ethernet

For internal communication between the CIU and the dosing pump, GENIbus is used.



The maximum cable length for GENIbus connection is 3 m and must not be exceeded.

Prior to installation and startup, read the documentation delivered with the CIU unit.

### 7.17.3 Activate communication

1. Set the pump to operating state "Stop" with the [Start/stop] key.
2. Switch off the power supply of the pump.
3. Install and connect the CIU as described in the respective separate installation and operating instructions.
4. Switch on the power supply of the pump.

The "Activate communication?" prompt is displayed.

After confirmation, the "Bus" symbol appears in the "Activated functions" area of the "Operation" menu, no matter if the prompt was accepted or refused.

If the prompt has been accepted, the bus control function is activated. If the prompt has been refused, bus control function can be activated in "Setup > Bus" menu.



Fig. 39 Example of submenu for Profibus®



The maximum cable length for GENIbus connection is 3 m and must not be exceeded.

TM06 7111 2916

TM06 7111 2916

### 7.17.4 Setting the bus address

1. Enter "Setup > Bus" menu and set desired bus address:

Bus type	Address range
Profibus® DP	0-126
Modbus RTU	1-247

2. The pump needs to be restarted to initialise the new bus address. Switch off the power supply of the pump and wait for approximately 20 seconds.
3. Switch on the power supply of the pump.  
The pump is initialised with the new bus address.

### 7.17.5 Characteristics of bus communication

To start and stop the pump via bus, it needs to be in operating state "Running". When the pump is remotely stopped from bus, the "External stop" symbol is displayed and the pump switches to operating state "Standby".

While bus control function is activated, the "Setup" menu only shows the "Bus" and "Key lock" submenus. The other main menus, the "External stop" function and the keys are still available.

All operation modes (see section [7.4 Operation modes](#)) can still be used when bus control is activated. This allows to use the bus control only for monitoring and setting the pump. In this case the respective "BusWatchDog" (see functional profile on CIM/CIU product CD) should be deactivated in bus control, because otherwise faults in communication can stop the pump.



To change any settings manually, the bus control function must be deactivated temporarily.

### 7.17.6 Deactivate communication

After deactivating the bus control function, the pump can start automatically.

#### CAUTION

##### Automatic startup



- Minor or moderate personal injury
- Before deactivating the bus control function, set the pump to operating state "Stop".

Bus control function can be deactivated in the "Setup > Bus" menu. After deactivation all submenus in "Setup" menu are available.

The "Bus" symbol in the display disappears at next restart of the pump, after the CIU plug was disconnected.



- After disconnecting any plug, always refit protective cap.

### 7.17.7 Communication faults

Faults are only detected, if the respective "BusWatchDog" (see functional profile on CIM/CIU product CD) is activated.

After a communication fault is repaired, the pump can start automatically, depending on current bus control and pump settings.

#### CAUTION

##### Automatic startup



- Minor or moderate personal injury
- Before repairing any fault, set the pump to operating state "Stop".

In case of bus communication faults (e.g. communication cable break), the pump stops dosing and switches to operating state "Standby" approximately 10 seconds after the fault was detected. An alarm is triggered, detailing the cause of the fault. See section [9. Faults](#).

## 7.18 Inputs/Outputs

In the "Setup > Inputs/Outputs" menu, you can configure the two outputs "Relay 1+Relay 2" and the signal inputs "External stop", "Empty signal" and "Low-level signal".

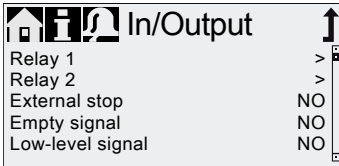

Fig. 40 Inputs/Outputs menu

When time or date is changed in "Time+date" menu, timer dosing and timer relay output functions (Relay 2) are stopped!



Timer dosing and timer relay output functions must be restarted manually!

Changing time or date can cause increase or decrease in concentration!

TM06 7112 2916

### 7.18.1 Relay outputs

The pump can switch two external signals using installed relays. The relay outputs are potential-free. The connection diagram of the relays is shown in section 5.3 *Electrical connection*. Both relays can be allocated with the following signals:

Relay 1 signal	Relay 2 signal	Description
Alarm*	Alarm	Display red, pump stopped (e.g. empty signal, etc.)
Warning*	Warning	Display yellow, pump is running (e.g. low-level signal, etc.)
Stroke signal	Stroke signal	Each full stroke
Pump dosing	Pump dosing*	Pump running and dosing
Pulse input**	Pulse input**	Each incoming pulse from pulse input
Bus control	Bus control	Activated by a command in the bus communication
	Timer Cycle	See following sections
	Timer Week	See following sections
<b>Contact type</b>		
NO*	NO*	Normally open contact
NC	NC	Normally closed contact

\* Factory setting

\*\* The correct transmission of incoming pulses can only be guaranteed up to a pulse frequency of 5 Hz.



Continuous operation of the relays on a high frequency reduces the relay lifetime significantly.

### Timer Cycle (Relay 2)

For the "Relay 2 > Timer Cycle" function, set the following parameters:

- On ( $t_1$ )
- Start delay ( $t_2$ )
- Cycle time ( $t_3$ ).

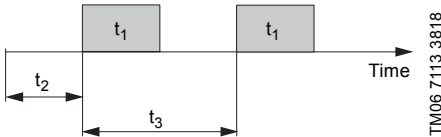

Fig. 41 Diagram

### Timer Week (Relay 2)

This function saves up to 16 relay on-times for a week. The following settings can be made for each relay switching operation in the "Relay 2 > Timer Week" menu:

- Procedure (No.)
- On time (duration)
- Start time
- Weekdays.

#### 7.18.2 External stop

The pump can be stopped via an external contact, e.g. from a control room. When activating the external stop signal, the pump switches to operating state "Standby". The corresponding symbol appears in the "Signal/error display" area of the display.

Frequent disengagement from the mains voltage, e.g. via a relay, can result in damage to the pump electronics and in the breakdown of the pump. The dosing accuracy is also reduced as a result of internal start procedures.



Do not control the pump via the mains voltage for dosing purposes!

Only use the "External stop" function to start and stop the pump!

The contact type is factory-set to normally open contact (NO). In the "Setup > Inputs/Outputs > External stop" menu, the setting can be changed to normally closed contact (NC).

#### 7.18.3 Empty and Low level signals

In order to monitor the filling level in the tank, a dual-level sensor can be connected to the pump. The pump responds to the signals as follows:

Sensor signal	Pump status
Low level	<ul style="list-style-type: none"> <li>• Display is yellow</li> <li>• ▼ Flashes</li> <li>• Pump continues running</li> </ul>
Empty	<ul style="list-style-type: none"> <li>• Display is red</li> <li>• ▼ Flashes</li> <li>• Pump stops dosing</li> </ul>

### CAUTION



#### Automatic startup

- Minor or moderate personal injury
- When the tank is filled up again, the pump restarts automatically.

Both signal inputs are allocated to the normally open contact (NO) in the factory. They can be re-allocated in the "Setup > Inputs/Outputs" menu to normally closed contact (NC).

#### 7.19 Basic settings

All settings can be reset to the settings default upon delivery in the "Setup > Basic settings" menu.

Selecting "Save customer settings" saves the current configuration to the memory. This can then be activated using "Load customer settings".

The memory always contains the previously saved configuration. Older memory data is overwritten.

## 8. Service

In order to ensure a long service life and dosing accuracy, wearing parts such as diaphragms and valves must be regularly checked for signs of wear. Where necessary, replace worn parts with original spare parts made from suitable materials.

Should you have any questions, please contact your Grundfos service partner.

Maintenance work must only be carried out by qualified persons.



The pump housing must only be opened by persons authorised by Grundfos. Observe section [8.7 Repairs](#).

### 8.1 Regular maintenance

Interval	Task
Daily	Check, if liquid leaks from the drain opening on the dosing head and if the drain opening is blocked or soiled. See fig. <a href="#">44-45</a> , pos. 8. If so, follow the instructions given in section <a href="#">8.6 Diaphragm leakage</a> .
	Check, if liquid leaks from the dosing head or valves. If necessary, tighten dosing head screws with a torque wrench. Torque [Nm]: 6 (+ 1). If necessary, tighten valves and cap nuts, or perform service. See section <a href="#">8.4 Perform service</a> .
	Check, if a service requirement is present at the pump display. If so, follow the instructions given in section <a href="#">8.3 Service system</a> .
Weekly	Clean all pump surfaces with a dry and clean cloth.
Every 3 months	Check dosing head screws. If necessary, tighten dosing head screws with a torque wrench. Torque [Nm]: 6 (+ 1). Replace damaged screws immediately.

### 8.2 Cleaning

If necessary, clean all pump surfaces with a dry and clean cloth.

## 8.3 Service system

According to the motor runtime or after a defined period of operation, service requirements will appear. Service requirements appear regardless of the current operating state of the pump and do not affect the dosing process.

Service requirement	Motor runtime [h]*	Time interval [months]*
Service soon!	7500	23
Service now!	8000	24

\* Since the last service system reset

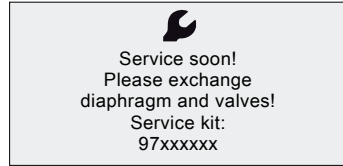

Fig. 42 Service soon!

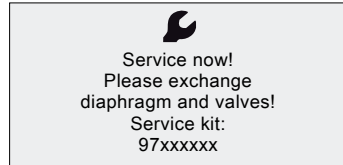

Fig. 43 Service now!

For media which result in increased wear, the service interval must be shortened.

The service requirement signals when the replacement of wearing parts is due and displays the order number of the service kit. Press the click wheel to temporarily hide the service prompt.

The displayed service kit contains the standard service parts.

For the full range of service kits and spare parts see the service kit catalogue:

- [http://net.grundfos.com/qr/i/96488862\\_23](http://net.grundfos.com/qr/i/96488862_23) or the Grundfos Product Center:
- <https://product-selection.grundfos.com>

When the "Service now!" message appears (displayed daily), the pump must be serviced immediately. The  symbol appears in the "Operation" menu.

The order number of the service kit required is also displayed in the "Info" menu.

TM06 7117 2916

TM06 7117 2916



## 8.4 Perform service

Only spare parts and accessories from Grundfos should be used for maintenance. The usage of non-original spare parts and accessories renders any liability for resulting damages null and void.

### CAUTION

#### Chemical hazard

Minor or moderate personal injury

- Observe the material safety data sheet of the dosing medium.
- Wear protective clothing (gloves and goggles) when working on the dosing head, connections or lines.
- Collect and dispose of all chemicals in a way that is not harmful to humans, animals and the environment.



Before starting work on the pump, the pump must be in the "Stop" operating state or be disconnected from the power supply. The system must be pressureless.

8.4.1 Service overview

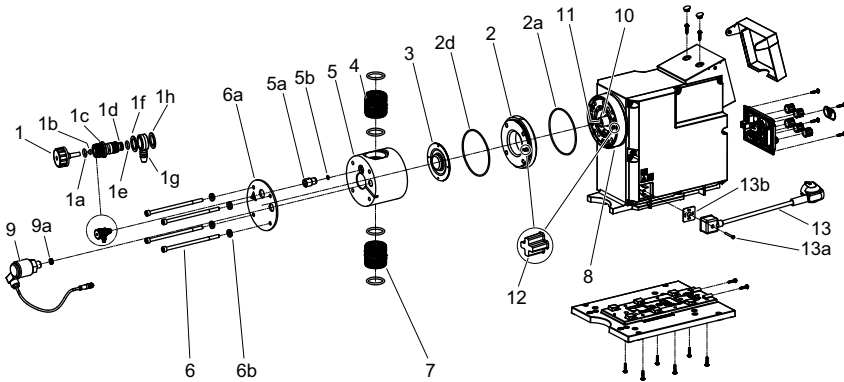

Fig. 44 DDA 60-10

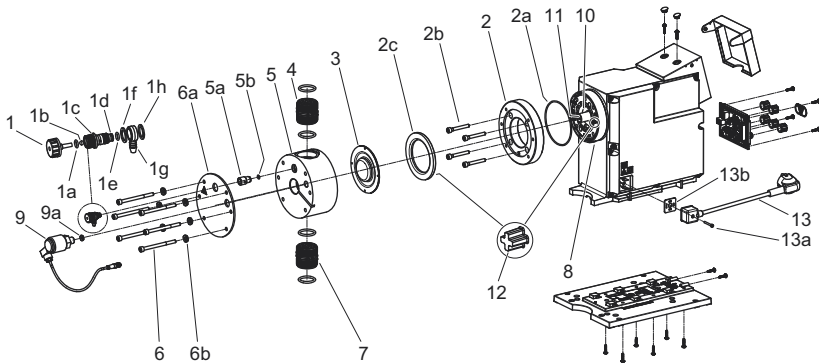

Fig. 45 DDA 120-7 / DDA 200-4

Pos.	Components
1	Deaeration screw
1a, 1e	O-ring
1b	Valve ball
1c	Valve housing
1d	Groove for O-ring
1f, 1h	Flat gasket
1g	Hose nipple
2	Flange
2a, 2d	O-ring
2b	Screws
2c	Intermediate ring
3	Diaphragm
4	Valve on outlet side
5	Dosing head
5a	Double nipple
5b	O-ring
6	Screws

Pos.	Components
6a	Cover plate (plastic dosing heads only)
6b	Washers (stainless steel dosing heads only)
7	Valve on inlet side
8	Drain opening
9	DLD sensor
9a	Gasket
10	Safety diaphragm
11	Extension piece
12	Alignment pin
13	Mains cable
13a	Safety screw
13b	Gasket

TM06 7119 4718

TM06 7678 4718

### 8.4.2 Dismantling the dosing head, diaphragm and valves



If the diaphragm is possibly damaged, don't connect the pump to the power supply! Proceed as described in section [8.6 Diaphragm leakage](#).

This section refers to fig. [44-45](#).

1. Put on the stipulated personal protective equipment.
2. Set pump to "Stop" ■ operating state using the [Start/stop] key.
3. Make system pressureless.
4. Take suitable steps to ensure that the returning liquid is safely collected.
5. Empty dosing head and flush it if necessary.
6. Press the [Start/stop] and [100%] keys at the same time to put the diaphragm into "out" position.
  - Symbol – must be displayed (see fig. [17](#)).
  - If the "Stop after power failure" alarm is active, acknowledge the alarm by opening the "Alarm" main menu. Otherwise the diaphragm cannot be moved.
7. Dismantle inlet, outlet and deaeration lines.
8. Unscrew valves on inlet and outlet side (4, 7).
9. Disconnect FlowControl or DLD signal connection, if present. See fig. [13-14](#).
10. For plastic dosing head:
  - Remove screws (6).
  - Remove dosing head (5) together with cover plate (6a).
11. For stainless steel dosing head:
  - Remove screws (6) together with washers (6b).
  - Remove dosing head (5).
12. Unscrew diaphragm (3) counter-clockwise and remove it.
13. DDA 60-10:
  - Remove flange (2) together with O-rings (2a, 2d).
14. DDA 120-7 / DDA 200-4:
  - Remove intermediate ring (2c).
  - Remove screws (2b) together with flange (2) and O-ring (2a).
15. Make sure the drain opening (8) is not blocked or soiled. Clean if necessary.
16. Check the safety diaphragm (10) for wear and damage. If the safety diaphragm is damaged, send the pump to Grundfos for repair. See section [8.7 Repairs](#).

If nothing indicates that dosing liquid has entered the pump housing, go on as described in section [8.4.3 Reassembling the dosing head, diaphragm and valves](#). Otherwise proceed as described in section [8.6.2 Dosing liquid in the pump housing](#).

### 8.4.3 Reassembling the dosing head, diaphragm and valves

The pump must only be reassembled, if nothing indicates that dosing liquid has entered the pump housing. Otherwise proceed as described in section [8.6.2 Dosing liquid in the pump housing](#).

This section refers to fig. [44-45](#).

1. DDA 60-10:
  - Place new O-rings (2a, 2d) in the grooves at flange (2) and make sure they are seated correctly.
  - Attach flange (2) observing alignment pin (12).
2. DDA 120-7 / DDA 200-4:
  - Install flange (2) and new O-ring (2a) with screws (2b) observing alignment pin (12). Make sure the O-ring is seated correctly.
  - Cross-tighten screws (2b) with a torque wrench. Torque [Nm]: 6 (+ 1).
  - Attach intermediate ring (2c) to flange (2) observing alignment pin (12).
3. Screw on the new diaphragm (3) clockwise.
  - Make sure the diaphragm is screwed on completely and fully resting on extension piece (11).
4. Press the [Start/stop] and [100%] keys at the same time to put the diaphragm into "in" position.
  - Symbol – must be displayed (see fig. [17](#)).
5. Attach dosing head (5).
  - DDA 60-10: Observe alignment pin (12).
6. For plastic dosing head:
  - Install screws (6) through cover plate (6a).
7. For stainless steel dosing head:
  - Install screws (6) with washers (6b).
8. Cross-tighten screws (6) with a torque wrench.
  - Torque [Nm]: 6 (+ 1).
9. Connect FlowControl or DLD signal connection, if present. See fig. [13-14](#).
10. Install new valves (4, 7).
  - Pay attention to the flow direction arrow.
  - Make sure the O-rings are seated correctly.
11. Perform hydraulic connection. See section [5.2 Hydraulic connection](#).
12. Press the [Start/stop] key to leave the service mode.
  - Tighten the dosing head screws with a torque wrench before startup and every time the dosing head has been opened. After 48 operating hours, retighten the dosing head screws using a torque wrench. Torque [Nm]: 6 (+ 1).
13. Deaerate the dosing pump. See section [6.4 Deaerating the pump](#).
14. Observe the notes on commissioning in section [6. Startup](#).
15. If you installed a new dosing head with pressure sensor, perform sensor calibration. See section [7.9.2 Calibration of pressure sensor](#).



Tighten the dosing head screws with a torque wrench before startup and every time the dosing head has been opened. After 48 operating hours, retighten the dosing head screws using a torque wrench. Torque [Nm]: 6 (+ 1).

### 8.4.4 Replacing the deaeration valve

This procedure requires a special tool kit. See service kit catalogue:

- [http://net.grundfos.com/qr/li/96488862\\_23](http://net.grundfos.com/qr/li/96488862_23)

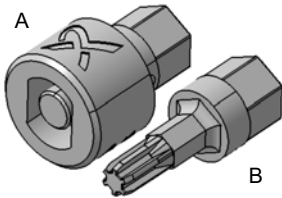

Fig. 46 Special tool kit

TM07 2852 4218

Pos.	Description
A	Special tool for valve housing
B	Special tool for double nipple

This section refers to fig. 44-46.

- Put on the stipulated personal protective equipment.
- Switch off the power supply.
- Make system pressureless.
- Take suitable steps to ensure that the returning liquid is safely collected.
- Empty dosing head and flush it if necessary.
- Dismantle deaeration line.
- Manually unscrew deaeration screw (1).
  - Do not use any tools, otherwise deaeration valve parts can break.
  - O-ring (1a) normally remains on the deaeration screw.
  - Valve ball (1b) normally remains in valve housing (1c).
- Use special tool (A) to unscrew valve housing (1c) from double nipple (5a).
- Remove hose nipple (1g) and flat gaskets (1f, 1h).
- Use special tool (B) to unscrew double nipple (5a).

Reassemble the deaeration valve with new parts as follows:

- Put in O-ring (5b).
- Use special tool (B) to screw in the new double nipple (5a) carefully with a torque wrench.
  - Torque [Nm]: 3 (+/- 0.2).
- Make sure that O-ring (1e) is seated correctly in groove (1d).
- Put flat gasket (1f) followed by hose nipple (1g) and flat gasket (1h) onto valve housing (1c).
- Use special tool (A) to screw in valve housing (1c) into double nipple (5a) carefully with a torque wrench.
  - Torque [Nm]: 2 (+/- 0.2).
- Make sure that O-ring (1a) is placed correctly on deaeration screw (1).

- Check that valve ball (1b) is correctly pre-assembled in valve housing (1c).
- Manually screw in deaeration screw (1).
- Deaerate the dosing pump. See section [6.4 Deaerating the pump](#).
- Observe the notes on commissioning in section [6. Startup](#).

### 8.4.5 Replacing the DLD sensor

This section refers to fig. 44-45.

- Put on the stipulated personal protective equipment.
- Switch off the power supply.
- Make system pressureless.
- Take suitable steps to ensure that the returning liquid is safely collected.
- Empty dosing head and flush it if necessary.
- Disconnect DLD signal connection. See fig. 14.
- Carefully unscrew DLD sensor (9) with an open-end spanner that fits accurately.
- Replace gasket (9a).
- Carefully screw in the new sensor into the dosing head with an open-end spanner that fits accurately.
  - Torque [Nm]: 2 (+ 0.5).
- Connect DLD signal connection.
- Deaerate the dosing pump. See section [6.4 Deaerating the pump](#).
- Observe the notes on commissioning in section [6. Startup](#).

### 8.4.6 Replacing the mains cable

All electrical connections must be carried out by a qualified electrician in accordance with local regulations.

- Disconnect the pump from the power supply.
- Unscrew safety screw (13a).
- Replace mains cable (13) and gasket (13b).
- Carefully screw in safety screw (13a) with a torque wrench.
  - Torque [Nm]: 0.4 (+/- 0.1)

The pump can start automatically when the power supply is switched on.

## CAUTION

### Automatic startup



Minor or moderate personal injury  
 - Make sure the pump has been correctly installed and is ready to be started before you switch on the power supply.

The enclosure class (IP65 / Nema 4X) is only guaranteed if plugs or protective caps are correctly installed.

Do not manipulate mains plug or cable.

### 8.5 Resetting the service system

After performing the service, the service system must be reset using the "Info > Reset service system" function.

## 8.6 Diaphragm leakage

If the diaphragm leaks or is broken, dosing liquid escapes from the drain opening on the dosing head. See fig. 4, pos. 16.

In case of diaphragm leakage, the safety diaphragm (fig. 44-45, pos. 10) protects the pump housing against ingress of dosing liquid.

When dosing crystallising liquids the drain opening can be blocked by crystallisation. If the pump is not taken out of operation immediately, a pressure can build up between the diaphragm (fig. 44-45, pos. 3) and the safety diaphragm. The pressure can press dosing liquid through the safety diaphragm into the pump housing.

Most dosing liquids don't cause any danger when entering the pump housing. However a few liquids can cause a chemical reaction with inner parts of the pump. In the worst case, this reaction can produce explosive gases in the pump housing.

### WARNING

#### Danger of explosion, if dosing liquid has entered the pump housing!

Death or serious personal injury  
Operation with damaged diaphragm can lead to dosing liquid entering the pump housing.

- In case of diaphragm leakage, immediately separate the pump from the power supply!
- Make sure the pump cannot be put back into operation by accident!
- Dismantle the dosing head without connecting the pump to the power supply and make sure no dosing liquid has entered the pump housing. Proceed as described in section [8.6.1 Dismantling the dosing head, diaphragm and valves in case of diaphragm leakage](#).

To avoid any danger resulting from diaphragm leakage, observe the following:

- Perform regular maintenance. See section [8.1 Regular maintenance](#).
- Never operate the pump with blocked or soiled drain opening.
  - If the drain opening is blocked or soiled, proceed as described in section [8.6.1 Dismantling the dosing head, diaphragm and valves in case of diaphragm leakage](#).
- Take suitable precautions to prevent harm to health and damage to property from escaping dosing liquid.
- Never operate the pump with damaged or loose dosing head screws.

## 8.6.1 Dismantling the dosing head, diaphragm and valves in case of diaphragm leakage



Do not connect the pump to the power supply!

This section refers to fig. 44-45.

1. Put on the stipulated personal protective equipment.
2. Make system pressureless.
3. Take suitable steps to ensure that the returning liquid is safely collected.
4. Empty dosing head and flush it if necessary.
5. Dismantle inlet, outlet and deaeration lines.
6. Unscrew valves on inlet and outlet side (4, 7).
7. Disconnect FlowControl or DLD signal connection, if present. See fig. 13-14.
8. For plastic dosing head:
  - Remove screws (6).
  - Remove dosing head (5) together with cover plate (6a).
9. For stainless steel dosing head:
  - Remove screws (6) together with washers (6b).
  - Remove dosing head (5).
10. Unscrew diaphragm (3) counter-clockwise and remove it.
11. DDA 60-10:
  - Remove flange (2) together with O-rings (2a, 2d).
12. DDA 120-7 / DDA 200-4:
  - Remove intermediate ring (2c).
  - Remove screws (2b) together with flange (2) and O-ring (2a).
13. Make sure the drain opening (8) is not blocked or soiled. Clean if necessary.
14. Check the safety diaphragm (10) for wear and damage. If the safety diaphragm is damaged, send the pump to Grundfos for repair. See section [8.7 Repairs](#).

If nothing indicates that dosing liquid has entered the pump housing, go on as described in section [8.4.3 Reassembling the dosing head, diaphragm and valves](#). Otherwise proceed as described in section [8.6.2 Dosing liquid in the pump housing](#).

### 8.6.2 Dosing liquid in the pump housing



Immediately separate the pump from the power supply!

Make sure the pump cannot be put back into operation by accident!

If dosing liquid has entered the pump housing:

- Send the pump to Grundfos for repair, following the instructions given in section [8.7 Repairs](#).
- If a repair isn't economically reasonable, dispose of the pump observing the information in section [10. Disposal](#).

## 8.7 Repairs



The pump housing must only be opened by persons authorised by Grundfos.

Repairs must only be carried out by authorised and qualified persons.

For pump repair contact your local Grundfos supplier. If your local Grundfos supplier asks you to send the pump to Grundfos for repair, fill in the safety declaration in English and attach it to the pump for shipping. The safety declaration can be found at the end of these instructions.



The pump must be cleaned prior to dispatch!

If dosing liquid has possibly entered the pump housing, state that explicitly in the safety declaration! Observe section [8.6 Diaphragm leakage](#).

If the above requirements are not met, Grundfos may refuse to accept delivery of the pump. The shipping costs will be charged to the sender.

Observe section [2.3 Transport](#).

## 9. Faults

In the event of faults, a warning or an alarm is triggered. The corresponding fault symbol flashes in the "Operation" menu, see section [9.1 List of faults](#). The cursor jumps to the "Alarm" main menu symbol.

Some alarms are automatically acknowledged by opening the "Alarm" main menu, which can cause the pump to start.

### CAUTION

#### Automatic startup



Minor or moderate personal injury

- Before entering the "Alarm" main menu, make sure the pump is in operating state "Stop".

Press the click wheel to open the "Alarm" main menu.

A yellow display indicates a warning and the pump continues running.

A red display indicates an alarm and the pump stops dosing. For some alarms the pump tries to restart periodically. When the cause of the alarm has been remedied, the pump starts automatically and switches back to normal operation.

### CAUTION

#### Automatic startup



Minor or moderate personal injury

- Before remedying the cause of the fault, make sure the pump is ready to be started.



Before starting work on the pump, the pump must be in the "Stop" operating state or be disconnected from the power supply. The system must be pressureless.

The last 10 faults are stored in the "Alarm" main menu. When a new fault occurs, the oldest fault is deleted.

The two most recent faults are shown in the display, you can scroll through all the other faults. The time and cause of the fault are displayed.

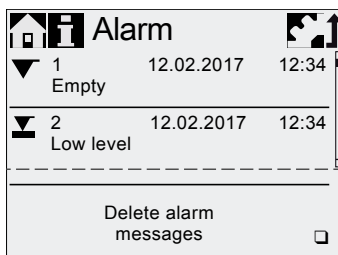











The list of faults can be deleted at the end of the list. If there is a service requirement, this appears when the "Alarm" menu is opened. Press the click wheel to temporarily close the service prompt. See section [8.3 Service system](#).





## 9.1 List of faults

### 9.1.1 Faults with error message

Display in the "Alarm" menu	Possible cause	Possible remedy
▼ Empty (Alarm)	<ul style="list-style-type: none"> <li>Dosing medium tank empty</li> </ul>	<ul style="list-style-type: none"> <li>Fill tank.</li> <li>Check plug connection.</li> </ul>
▼ Low level (Warning)	<ul style="list-style-type: none"> <li>Dosing medium tank almost empty</li> </ul>	<ul style="list-style-type: none"> <li>Check contact setting (NO/NC).</li> </ul>
👁 Overpressure (Alarm)	<ul style="list-style-type: none"> <li>Outlet valve blocked</li> </ul>	<ul style="list-style-type: none"> <li>Replace valve if necessary. See section <a href="#">8.4 Perform service</a>.</li> </ul>
	<ul style="list-style-type: none"> <li>Isolating valve in outlet line closed</li> </ul>	<ul style="list-style-type: none"> <li>Check flow direction of valves (arrow) and correct if necessary.</li> <li>Open the isolating valve (on the outlet side).</li> </ul>
	<ul style="list-style-type: none"> <li>Backpressure exceeds max. operating pressure</li> </ul>	<ul style="list-style-type: none"> <li>Reduce backpressure. Observe section <a href="#">4.1 Technical data</a>.</li> </ul>
	<ul style="list-style-type: none"> <li>Pressure peaks due to high viscosity</li> </ul>	<ul style="list-style-type: none"> <li>Enlarge diameter of outlet line.</li> </ul>
👁 Low backpressure (Warning/alarm*)	<ul style="list-style-type: none"> <li>Max. pressure is set too low. See section <a href="#">7.9 Pressure monitoring</a>.</li> </ul>	<ul style="list-style-type: none"> <li>Change pressure setting. See section <a href="#">7.9 Pressure monitoring</a>.</li> </ul>
	<ul style="list-style-type: none"> <li>Faulty diaphragm</li> </ul>	<ul style="list-style-type: none"> <li>Change the diaphragm. See section <a href="#">8.4 Perform service</a>.</li> </ul>
	<ul style="list-style-type: none"> <li>Broken outlet line</li> </ul>	<ul style="list-style-type: none"> <li>Check outlet line and repair if necessary.</li> </ul>
👁 Air bubble (Warning)	<ul style="list-style-type: none"> <li>Pressure differential between inlet and outlet side too low</li> <li>Leakage in the pressure loading valve at <math>Q &lt; 1 \text{ l/h}</math></li> </ul>	<ul style="list-style-type: none"> <li>Install additional spring-loaded valve (approx. 2 bar) on the outlet side to increase the pressure differential.</li> </ul>
	<ul style="list-style-type: none"> <li>Deaeration valve open</li> </ul>	<ul style="list-style-type: none"> <li>Close the deaeration valve.</li> </ul>
	<ul style="list-style-type: none"> <li>Broken/leaky inlet line</li> </ul>	<ul style="list-style-type: none"> <li>Check inlet line and repair if necessary.</li> <li>Provide positive inlet pressure (place dosing medium tank above the pump).</li> </ul>
👁 Cavitation (Warning)	<ul style="list-style-type: none"> <li>Strongly degassing medium</li> </ul>	<ul style="list-style-type: none"> <li>Enable "SlowMode". See section <a href="#">7.6 SlowMode</a>.</li> </ul>
	<ul style="list-style-type: none"> <li>Tank dosing medium empty</li> </ul>	<ul style="list-style-type: none"> <li>Fill tank.</li> </ul>
	<ul style="list-style-type: none"> <li>Blocked / constricted / squeezed inlet line</li> </ul>	<ul style="list-style-type: none"> <li>Enable "SlowMode". See section <a href="#">7.6 SlowMode</a>.</li> </ul>
👁 Suct. valve leak (Warning)	<ul style="list-style-type: none"> <li>Blocked/constricted inlet valve</li> <li>Suction lift too high</li> <li>Viscosity too high</li> </ul>	<ul style="list-style-type: none"> <li>Reduce suction lift.</li> <li>Increase inlet line diameter.</li> <li>Check inlet line and open isolating valve if necessary.</li> </ul>
	<ul style="list-style-type: none"> <li>Leaky/dirty inlet valve. Dosing medium flows back from the dosing head into the inlet line which reduces the target flow.</li> <li>Leakage in pressure valve or pressure loading valve</li> </ul>	<ul style="list-style-type: none"> <li>Check valve and tighten it up.</li> <li>Flush system.</li> <li>Replace valve if necessary. See section <a href="#">8.4 Perform service</a>.</li> <li>Check O-ring position.</li> <li>Install strainer in inlet line.</li> </ul>
	<ul style="list-style-type: none"> <li>Deaeration valve open</li> </ul>	<ul style="list-style-type: none"> <li>Close the deaeration valve.</li> </ul>
👁 Flow deviation (Warning)	<ul style="list-style-type: none"> <li>Considerable deviation between target and actual flow</li> </ul>	<ul style="list-style-type: none"> <li>Check installation.</li> </ul>
	<ul style="list-style-type: none"> <li>Pump not or incorrectly calibrated</li> </ul>	<ul style="list-style-type: none"> <li>Calibrate the pump. See section <a href="#">6.5 Calibrating the pump</a>.</li> </ul>

Display in the "Alarm" menu	Possible cause	Possible remedy
 Disch. valve leak (Warning)	<ul style="list-style-type: none"> <li>Leaky/dirty outlet valve. Dosing medium flows back from the outlet line into the dosing head which reduces the target flow.</li> </ul>	<ul style="list-style-type: none"> <li>Check valve and tighten it up. Replace valve if necessary. See section <a href="#">8.4 Perform service</a>.</li> <li>Flush system.</li> <li>Check O-ring position.</li> <li>Install strainer in inlet line.</li> <li>Install spring-loaded valve on the outlet side.</li> </ul>
 Overload (Alarm)	<ul style="list-style-type: none"> <li>Backpressure exceeds max. operating pressure</li> <li>Outlet valve blocked</li> <li>Isolating valve in outlet line closed</li> </ul>	<ul style="list-style-type: none"> <li>Reduce backpressure. Observe section <a href="#">4.1 Technical data</a>.</li> <li>Replace valve if necessary. See section <a href="#">8.4 Perform service</a>.</li> <li>Check flow direction of valves (arrow) and correct if necessary.</li> <li>Open the isolating valve (on the outlet side).</li> </ul>
 Pressure peaks	<ul style="list-style-type: none"> <li>Pressure peaks</li> </ul>	<ul style="list-style-type: none"> <li>Enlarge diameter of outlet line.</li> <li>Install a pulsation damper in the outlet line close to the outlet valve.</li> </ul>
 Ambient temperature below specified minimum value. See section <a href="#">4.1 Technical data</a> .	<ul style="list-style-type: none"> <li>Ambient temperature below specified minimum value. See section <a href="#">4.1 Technical data</a>.</li> </ul>	<ul style="list-style-type: none"> <li>Adjust ambient temperature to specified value.</li> </ul>
 Pressure sensor (Warning)	<ul style="list-style-type: none"> <li>Broken "FlowControl" cable or sensor (see fig. <a href="#">13</a>)</li> </ul>	<ul style="list-style-type: none"> <li>Check plug connection.</li> <li>Replace dosing head with sensor if necessary.</li> <li>If the "Flow control" connection at the pump is damaged, send the pump for repair. See section <a href="#">8.7 Repairs</a>.</li> </ul>
 Motor blocked (Alarm)	<ul style="list-style-type: none"> <li>Backpressure greater than nominal pressure</li> <li>Incorrectly installed diaphragm</li> <li>Damage to gears</li> <li>Hall sensor failure</li> <li>Motor failure</li> </ul>	<ul style="list-style-type: none"> <li>Reduce backpressure.</li> <li>Install the diaphragm correctly.</li> <li>Contact your Grundfos service partner.</li> </ul>
 Bus error (Alarm)	<ul style="list-style-type: none"> <li>Fieldbus communication error</li> </ul>	<ul style="list-style-type: none"> <li>Check cables for correct specification and damage; replace if necessary.</li> <li>Check cable routing and shielding; correct if necessary.</li> </ul>
 CIU (Alarm)	<ul style="list-style-type: none"> <li>CIU connection error</li> <li>Faulty CIU</li> </ul>	<ul style="list-style-type: none"> <li>Check plug connection.</li> <li>Replace CIU if necessary.</li> </ul>
 Sensor signal (Alarm)	<ul style="list-style-type: none"> <li>Sensor signal out of range 0/4-20 mA</li> </ul>	<ul style="list-style-type: none"> <li>Check cable/plug connections and replace, if necessary.</li> <li>Check signal transmitter.</li> </ul>
 Stop after power failure (Alarm)	<ul style="list-style-type: none"> <li>Function "Stop after power failure" is enabled and power supply was switched on or reestablished after power failure.</li> </ul>	<ul style="list-style-type: none"> <li>Check power supply and mains cable.</li> <li>Read section <a href="#">7.7 Stop after power failure</a>.</li> </ul>
 Diaphragm leak. (Alarm)	<ul style="list-style-type: none"> <li>Diaphragm leakage</li> </ul>	<ul style="list-style-type: none"> <li>Read section <a href="#">8.6 Diaphragm leakage</a></li> <li>Change the diaphragm. See section <a href="#">8.4 Perform service</a>.</li> </ul>



Display in the "Alarm" menu	Possible cause	Possible remedy
 Disch. valve leak (Alarm)	<ul style="list-style-type: none"> <li>Leaky/dirty outlet valve. Dosing medium flows back from the outlet line into the dosing head and moves the motor.</li> <li>Inlet pressure too high. Dosing medium flows from the inlet line into the dosing head and moves the motor.</li> </ul>	<ul style="list-style-type: none"> <li>Replace valve if necessary. See section <a href="#">8.4 Perform service</a>.</li> <li>Install screen in inlet line.</li> <li>Reduce inlet pressure. Observe section <a href="#">4.1 Technical data</a>.</li> </ul>
 Cavitation (Alarm)	<ul style="list-style-type: none"> <li>Blocked / constricted / squeezed inlet line</li> <li>Blocked/constricted inlet valve</li> <li>Suction lift too high</li> <li>Viscosity too high</li> <li>Cavitation moves the motor</li> </ul>	<ul style="list-style-type: none"> <li>Enable "SlowMode". See section <a href="#">7.6 SlowMode</a>.</li> <li>Reduce suction lift.</li> <li>Increase inlet line diameter.</li> <li>Check inlet line and open isolating valve if necessary.</li> </ul>
 Overheating (Alarm)	<ul style="list-style-type: none"> <li>Motor is overheated</li> </ul>	<ul style="list-style-type: none"> <li>Reduce ambient temperature.</li> <li>Stop pump until motor cools down.</li> </ul>
 Service now (Warning)	<ul style="list-style-type: none"> <li>Time interval for service expired</li> </ul>	<ul style="list-style-type: none"> <li>Perform service. See section <a href="#">8.4 Perform service</a>.</li> </ul>

\* Depending on setting

### 9.1.2 General faults

Fault	Possible cause	Possible remedy	
Dosing flow too high	Inlet pressure greater than backpressure	Install additional spring-loaded valve (approx. 2 bar) on the outlet side. Check settings. Increase pressure differential.	
	Incorrect calibration	Calibrate the pump. See section <a href="#">6.5 Calibrating the pump</a> .	
	Air in dosing head	Deaerate the pump.	
	Faulty diaphragm	Change the diaphragm. See section <a href="#">8.4 Perform service</a> .	
	Leakage/fracture in lines	Check and repair lines.	
	Valves leaking or blocked	Check and clean valves.	
No dosing flow or dosing flow too low	Valves installed incorrectly	Check that the arrow on the valve housing is pointing in the direction of flow. Check whether all O-rings are installed correctly.	
	Blocked inlet line	Clean inlet line/install strainer.	
	Suction lift too high	Reduce suction lift.	
		Install priming aid.	
	Viscosity too high	Enable "SlowMode". See section <a href="#">7.6 SlowMode</a> .	
		Use lines with larger diameter. Install spring-loaded inlet and outlet valve.	
	Faulty calibration	Calibrate the pump. See section <a href="#">6.5 Calibrating the pump</a> .	
	Deaeration valve open	Close the deaeration valve.	
	Irregular dosing	Valves leaking or blocked	Tighten up valves, replace valves if necessary. See section <a href="#">8.4 Perform service</a> .
		Backpressure fluctuations	Keep backpressure constant. Activate "AutoFlowAdapt" (only DDA-FCM).
Liquid escaping from the drain opening on the dosing head	Faulty diaphragm	Immediately separate the pump from the power supply! Observe section <a href="#">8. Service</a> and especially section <a href="#">8.6 Diaphragm leakage</a> .	
Liquid escaping	Dosing head screws not tightened	Tighten up screws. See section <a href="#">5.2 Hydraulic connection</a> .	
	Valves not tightened	Tighten up valves/union nuts. See section <a href="#">5.2 Hydraulic connection</a> .	
Pump not sucking in	Suction lift too high	Reduce suction lift; if necessary, provide positive inlet pressure.	
	Backpressure too high	Open the deaeration valve.	
	Soiled valves	Flush system, replace valves if necessary. See section <a href="#">8.4 Perform service</a> .	

## 10. Disposal

This product or parts of it must be disposed of in an environmentally sound way. Use appropriate waste collection services. If this is not possible, contact the nearest Grundfos company or service workshop.

See also end-of-life information at [www.grundfos.com/product-recycling](http://www.grundfos.com/product-recycling).

## Safety declaration

Please copy, fill in and sign this sheet and attach it to the pump returned for service.



Fill in this document using English or German language.

Product type (nameplate) \_\_\_\_\_

Model number (nameplate) \_\_\_\_\_

Dosing medium \_\_\_\_\_

### Fault description

Please make a circle around the damaged parts.

In the case of an electrical or functional fault, please mark the cabinet.

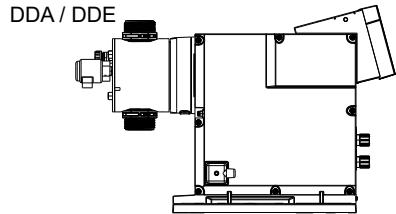
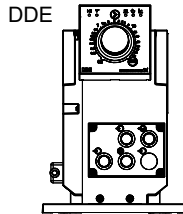
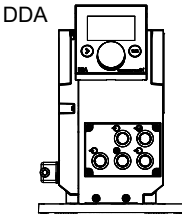

TM06 7265 3918

Please describe the error/cause of the error in brief.

Dosing liquid has possibly entered the pump housing.  
The pump must not be connected to the power supply! Danger of explosion!

We hereby declare that the pump has been cleaned and is completely free from chemical, biological and radioactive substances.

\_\_\_\_\_  
Date and signature

\_\_\_\_\_  
Company stamp

**Argentina**

Bombas GRUNDFOS de Argentina S.A.  
Ruta Panamericana km. 37.500 Centro  
Industrial Garin  
1619 - Garin Pcia. de B.A.  
Phone: +54-3327 414 444  
Telefax: +54-3327 45 3190

**Australia**

GRUNDFOS Pumps Pty. Ltd.  
P.O. Box 2040  
Regency Park  
South Australia 5942  
Phone: +61-8-8461-4611  
Telefax: +61-8-8340 0155

**Austria**

GRUNDFOS Pumpen Vertrieb  
Ges.m.b.H.  
Grundfosstraße 2  
A-5082 Grödig/Salzburg  
Tel.: +43-6246-883-0  
Telefax: +43-6246-883-30

**Belgium**

N.V. GRUNDFOS Bellux S.A.  
Boomsesteenweg 81-83  
B-2630 Aartselaar  
Tél.: +32-3-870 7300  
Télécopie: +32-3-870 7301

**Belarus**

Представительство ГРУНДФОС в  
Минске  
220125, Минск  
ул. Шафарнянская, 11, оф. 56, БЦ  
«Порт»  
Тел.: +7 (375 17) 286 39 72/73  
Факс: +7 (375 17) 286 39 71  
E-mail: minsk@grundfos.com

**Bosnia and Herzegovina**

GRUNDFOS Sarajevo  
Zmaja od Bosne 7-7A,  
BH-71000 Sarajevo  
Phone: +387 33 592 480  
Telefax: +387 33 590 465  
www.ba.grundfos.com  
e-mail: grundfos@bih.net.ba

**Brazil**

BOMBAS GRUNDFOS DO BRASIL  
Av. Humberto de Alencar Castelo  
Branco, 630  
CEP 09850 - 300  
São Bernardo do Campo - SP  
Phone: +55-11 4393 5533  
Telefax: +55-11 4343 5015

**Bulgaria**

Grundfos Bulgaria EOOD  
Slatina District  
Iztochna Tangenta street no. 100  
BG - 1592 Sofia  
Tel. +359 2 49 22 200  
Fax. +359 2 49 22 201  
email: bulgaria@grundfos.bg

**Canada**

GRUNDFOS Canada Inc.  
2941 Brighton Road  
Oakville, Ontario  
L6H 6C9  
Phone: +1-905 829 9533  
Telefax: +1-905 829 9512

**China**

**Grundfos Alldos  
Dosing & Disinfection**  
ALLDOS (Shanghai) Water Technology  
Co. Ltd.  
West Unit, 1 Floor, No. 2 Building (T 4-2)  
278 Jinhui Road, Jin Qiao Export  
Processing Zone  
Pudong New Area  
Shanghai, 201206  
Phone: +86 21 5055 1012  
Telefax: +86 21 5032 0596  
E-mail:  
grundfosalldos-CN@grundfos.com

**China**

GRUNDFOS Pumps (Shanghai) Co. Ltd.  
10F The Hub, No. 33 Suhong Road  
Minhang District  
Shanghai 201106  
PRC  
Phone: +86-21 6122 5222  
Telefax: +86-21 6122 5333

**COLOMBIA**

GRUNDFOS Colombia S.A.S.  
Km 1.5 vía Siberia-Cota Conj. Potrero  
Chico,  
Parque Empresarial Arcos de Cota Bod.  
1A,  
Cota, Cundinamarca  
Phone: +57(1)-2913444  
Telefax: +57(1)-8764586

**Croatia**

GRUNDFOS CROATIA d.o.o.  
Buzinski prilaz 38, Buzin  
HR-10010 Zagreb  
Phone: +385 1 6595 400  
Telefax: +385 1 6595 499  
www.hr.grundfos.com

**GRUNDFOS Sales Czechia and  
Slovakia s.r.o.**

Čapkovského 21  
779 00 Olomouc  
Phone: +420-585-716 111

**Denmark**

GRUNDFOS DK A/S  
Martin Bachs Vej 3  
DK-8850 Bjerringbro  
Tlf.: +45-87 50 50 50  
Telefax: +45-87 50 51 51  
E-mail: info\_GDK@grundfos.com  
www.grundfos.com/DK

**Estonia**

GRUNDFOS Pumps Eesti OÜ  
Peterburi tee 92G  
11415 Tallinn  
Tel: + 372 606 1690  
Fax: + 372 606 1691

**Finland**

OY GRUNDFOS Pumput AB  
Trukkikuja 1  
FI-01360 Vantaa  
Phone: +358-(0)207 889 500

**France**

Pompes GRUNDFOS Distribution S.A.  
Parc d'Activités de Chesnes  
57, rue de Malacombe  
F-38290 St. Quentin Fallavier (Lyon)  
Tél.: +33-4 74 82 15 15  
Télécopie: +33-4 74 94 10 51

**Germany**

GRUNDFOS Water Treatment GmbH  
Reetzstraße 85  
D-76327 Pfinztal (Söllingen)  
Tel.: +49 7240 61-0  
Telefax: +49 7240 61-177  
E-mail: gwt@grundfos.com

**Germany**

GRUNDFOS GMBH  
Schlüterstr. 33  
40699 Erkrath  
Tel.: +49-(0) 211 929 69-0  
Telefax: +49-(0) 211 929 69-3799  
E-mail: infoservice@grundfos.de  
Service in Deutschland:  
E-mail: kundendienst@grundfos.de

**Greece**

GRUNDFOS Hellas A.E.B.E.  
20th km. Athinon-Markopoulou Av.  
P.O. Box 71  
GR-19002 Peania  
Phone: +0030-210-66 83 400  
Telefax: +0030-210-66 46 273

**Hong Kong**

GRUNDFOS Pumps (Hong Kong) Ltd.  
Unit 1, Ground floor  
Siu Wai Industrial Centre  
29-33 Wing Hong Street &  
68 King Lam Street, Cheung Sha Wan  
Kowloon  
Phone: +852-27861706 / 27861741  
Telefax: +852-27858664

**Hungary**

GRUNDFOS Hungária Kft.  
Tópark u. 8  
H-2045 Törökbálint,  
Phone: +36-23 511 110  
Telefax: +36-23 511 111

**India**

GRUNDFOS Pumps India Private  
Limited  
118 Old Mahabalipuram Road  
Thoraiakkam  
Chennai 600 097  
Phone: +91-44 4596 6800

**Indonesia**

PT. GRUNDFOS POMPA  
Graha Intirub Lt. 2 & 3  
Jln. Ciliilitan Besar No.454. Makasar,  
Jakarta Timur  
ID-Jakarta 13650  
Phone: +62 21-469-51900  
Telefax: +62 21-460 6910 / 460 6901

**Ireland**

GRUNDFOS (Ireland) Ltd.  
Unit A, Merrywell Business Park  
Ballymount Road Lower  
Dublin 12  
Phone: +353-1-4089 800  
Telefax: +353-1-4089 830

**Italy**

GRUNDFOS Pompe Italia S.r.l.  
Via Gran Sasso 4  
I-20060 Truccazzano (Milano)  
Tel.: +39-02-95838112  
Telefax: +39-02-95309290 / 95838461

**Japan**

GRUNDFOS Pumps K.K.  
1-2-3. Shin-Miyakoda, Kita-ku  
Hamamatsu  
431-2103 Japan  
Phone: +81 53 428 4760  
Telefax: +81 53 428 5005

**Korea**

GRUNDFOS Pumps Korea Ltd.  
6th Floor, Aju Building 679-5  
Yeoksam-dong, Kangnam-ku, 135-916  
Seoul, Korea  
Phone: +82-2-5317 600  
Telefax: +82-2-5633 725

**Latvia**

SIA GRUNDFOS Pumps Latvia  
Deglava biznesa centrs  
Augusta Deglava ielā 60, LV-1035, Rīga,  
Tālr.: + 371 714 9640, 7 149 641  
Fakss: + 371 914 9646

**Lithuania**

GRUNDFOS Pumps UAB  
Smolensko g. 6  
LT-03201 Vilnius  
Tel: + 370 52 395 430  
Fax: + 370 52 395 431

**Malaysia**

GRUNDFOS Pumps Sdn. Bhd.  
7 Jalan Peguam U1/25  
Glenmarie Industrial Park  
40150 Shah Alam  
Selangor  
Phone: +60-3-5569 2922  
Telefax: +60-3-5569 2866

**Mexico**

Bombas GRUNDFOS de México S.A. de  
C.V.  
Boulevard TLC No. 15  
Parque Industrial Stiva Aeropuerto  
Apodaca, N.L. 66600  
Phone: +52-81-8144 4000  
Telefax: +52-81-8144 4010

**Netherlands**

GRUNDFOS Netherlands  
Veluwezoom 35  
1326 AE Almere  
Postbus 22015  
1302 CA ALMERE  
Tel.: +31-88-478 6336  
Telefax: +31-88-478 6332  
E-mail: info\_gnl@grundfos.com

**New Zealand**

GRUNDFOS Pumps NZ Ltd.  
17 Beatrice Tinsley Crescent  
North Harbour Industrial Estate  
Albany, Auckland  
Phone: +64-9-415 3240  
Telefax: +64-9-415 3250

**Norway**

GRUNDFOS Pumper A/S  
Strømsveien 344  
Postboks 235, Leirdal  
N-1011 Oslo  
Tlf.: +47-22 90 47 00  
Telefax: +47-22 32 21 50

**Poland**

GRUNDFOS Pompy Sp. z o.o.  
ul. Klonowa 23  
Baranowo k. Poznania  
PL-62-081 Przeźmierowo  
Tel: (+48-61) 650 13 00  
Fax: (+48-61) 650 13 50

**Portugal**

Bombas GRUNDFOS Portugal, S.A.  
Rua Calvet de Magalhães, 241  
Apartado 1079  
P-2770-153 Paço de Arcos  
Tel.: +351-21-440 76 00  
Telefax: +351-21-440 76 90

**Romania**

GRUNDFOS Pompe România SRL  
Bd. Biruintei, nr 103  
Pantelimon county Ilfov  
Phone: +40 21 200 4100  
Telefax: +40 21 200 4101  
E-mail: romania@grundfos.ro

**Russia**

ООО Грундфос Россия  
ул. Школьная, 39-41  
Москва, RU-109544, Russia  
Тел. (+7) 495 564-88-00 (495)  
737-30-00  
Факс (+7) 495 564 8811  
E-mail grundfos.moscow@grundfos.com

**Serbia**

Grundfos Srbija d.o.o.  
Omladinskih brigada 90b  
11070 Novi Beograd  
Phone: +381 11 2258 740  
Telefax: +381 11 2281 769  
www.rs.grundfos.com

**Singapore**

GRUNDFOS (Singapore) Pte. Ltd.  
25 Jalan Tukang  
Singapore 619264  
Phone: +65-6681 9688  
Telefax: +65-6681 9689

**Slovakia**

GRUNDFOS s.r.o.  
Prievozská 4D  
821 09 BRATISLAVA  
Phona: +421 2 5020 1426  
sk.grundfos.com

**Slovenia**

GRUNDFOS LJUBLJANA, d.o.o.  
Leskoškova 9e, 1122 Ljubljana  
Phone: +386 (0) 1 568 06 10  
Telefax: +386 (0)1 568 0619  
E-mail: tehnika-si@grundfos.com

**South Africa**

Grundfos (PTY) Ltd.  
16 Lascelles Drive, Meadowbrook Estate  
1609 Germiston, Johannesburg  
Tel.: (+27) 10 248 6000  
Fax: (+27) 10 248 6002  
E-mail: Igradidge@grundfos.com

**Spain**

Bombas GRUNDFOS España S.A.  
Camino de la Fuentequilla, s/n  
E-28110 Algete (Madrid)  
Tel.: +34-91-848 8800  
Telefax: +34-91-628 0465

**Sweden**

GRUNDFOS AB  
Box 333 (Lunnagårdsgatan 6)  
431 24 Mölndal  
Tel.: +46 31 332 23 000  
Telefax: +46 31 331 94 60

**Switzerland**

GRUNDFOS Pumpen AG  
Bruggacherstrasse 10  
CH-8117 Fällanden/ZH  
Tel.: +41-44-806 8111  
Telefax: +41-44-806 8115

**Taiwan**

GRUNDFOS Pumps (Taiwan) Ltd.  
7 Floor, 219 Min-Chuan Road  
Taichung, Taiwan, R.O.C.  
Phone: +886-4-2305 0868  
Telefax: +886-4-2305 0878

**Thailand**

GRUNDFOS (Thailand) Ltd.  
92 Chaloein Phrakiat Rama 9 Road,  
Dokmai, Pravej, Bangkok 10250  
Phone: +66-2-725 8999  
Telefax: +66-2-725 8998

**Turkey**

GRUNDFOS POMPA San. ve Tic. Ltd.  
Sti.  
Gebze Organize Sanayi Bölgesi  
İhsan dede Caddesi,  
2. yol 200. Sokak No. 204  
41490 Gebze/Kocaeli  
Phone: +90 - 262-679 7979  
Telefax: +90 - 262-679 7905  
E-mail: satis@grundfos.com

**Ukraine**

Бізнес Центр Європа  
Столичне шосе, 103  
м. Київ, 03131, Україна  
Телефон: (+38 044) 237 04 00  
Факс.: (+38 044) 237 04 01  
E-mail: ukraine@grundfos.com

**United Arab Emirates**

GRUNDFOS Gulf Distribution  
P.O. Box 16768  
Jebel Ali Free Zone  
Dubai  
Phone: +971-4- 8815 166  
Telefax: +971-4-8815 136

**United Kingdom**

GRUNDFOS Pumps Ltd.  
Grovebury Road  
Leighton Buzzard/Beds. LU7 4TL  
Phone: +44-1525-850000  
Telefax: +44-1525-850011

**U.S.A.**

GRUNDFOS Pumps Corporation  
9300 Loiret Blvd.  
Lenexa, Kansas 66219  
Phone: +1-913-227-3400  
Telefax: +1-913-227-3500

**Uzbekistan**

Grundfos Tashkent, Uzbekistan The  
Representative Office of Grundfos  
Kazakhstan in Uzbekistan  
38a, Oybek street, Tashkent  
Телефон: (+998) 71 150 3290 / 71 150  
3291  
Факс: (+998) 71 150 3292

Addresses revised 15.01.2019

**98767821** 0219

ECM: 1246835

Trademarks displayed in this material, including but not limited to Grundfos, the Grundfos logo and "be think innovate" are registered trademarks owned by The Grundfos Group. All rights reserved. © 2019 Grundfos Holding A/S, all rights reserved.